



FHD VIDEO DOOR PHONE

-Everything starts in the MORNING-

### Morning Technology Co.,Ltd

Room501,5th floor,2nd building,No.319 Huawei Road,  
Xiangzhou District,Zhuhai City,GuangDong Provice ,China  
Http://www.morningtech.com.cn  
E-mail:Ly@morningtech.com.cn



WIFI • AHD • ANALOG  
INTRODUCTION  
PRODUCT



FHD VIDEO DOOR PHONE  
Morning Technology Co.,Ltd

Product Line-Up

# CONTENTS

## WIFI

### Wifi Video Door Phone

96707-DP	3
96706-DP	4
96103-DP	5
96703-DP	6
96110-DP	7
96701-DP	8

## AHD Analog

### AHD Video Door Phone

94103HP/AP/MP	11
94110HP/AP/MP	12
94107HP/AP/MP	13
94102HP/AP/MP	14
94101HP/AP/MP	15
94711HP/AP/MP	16
94710HP/AP/MP	17
94708HP/AP/MP	18
94707HP/AP/MP	19
94706HP/AP/MP	20
94705HP/AP/MP	21
94703HP/AP/MP	22
94701HP/AP/MP	24
94401AP	25
94402EP/94411EP/94705EP/94711EP	26

## CALL PANEL

### AHD1080P Outdoor Bell

94206	27
94214	29
94202	30
94203	31
94204	32
94201	33
94207	34

# Company Profile

Zhuhai Morning Technology Co.,Ltd is one of the leading professional manufacturers which develops and produces Video Door Phones in Zhuhai city,Guangdong province, China. And its main products including: Audio video door phone, 4-wire analog video door phone, 4-wire AHD video door phone,IP video door phone. With the advanced technology developments, Morningtech is going to work on Smart home system .



“Everything starts in the MORNING”we are constantly raising our standards, and develop our technology according to the market trends and customers feedback. Morningtech promise that those who order products from us can rest assured that they are getting a custom-made solution of the favorable product performance.

We offer OEM/ODM service,best price,prompt delivery and personal service to meet our customers requirements.All our products get CE,FCC,RHOS certificates approval and we have been authorized by the ISO 9001(2015 version) Internal Management System.

Thanks for the continuous support from our partners and keep Zhuhai Morning rapid growing every year .We will be maximally efforts to reach the win-win situation among and society. And we will do our best to make Morningtech a respectable and world class manufacturer of Video Door Phone.



2002 | Founder(Mr.Nick) worked in security Industry since 2002

2010 | Mr.Nick is the first person developed a analog Video door phone

2016 | 2016, Moringtech Start to serve the customers and get CE,FCC,RHOS certificates approval for all products

2017 | Morningtech is the 1st company provide AHD720P Video door Phone in the market

2018 | Our technology leads the way ,AHD1080P Video door phone was successfully developed

2019 | Super WIFI Intercom with AHD 1080P system

NOW | Technological innovation is our goal



## Wifi Video Door Phone ▶

- Support IOS & Android smart phone
- Support Mobile Phone answer calling anywhere
- Support intercom between Call panel
- Support Mobile phone Unlock
- Support Alarm
- Support photo capture and video by mobile phone
- Able to connect 5 mobile user
- Cloud service
- Support Play movie and Music or Clock during standby mode
- Support Choose MP3 Ringtone
- Support Photo Frame
- Support photo capture and video recording
- Support Point to point transfer and Internal call
- Adjustable brightness , Contrast ,Ring volume and speaker volume
- Adjustable monitoring time from 120s-180s-240s-300s-ON all the time
- Up to 6 monitor and 2 doorbells and 2 CCTV cameras
- (AHD Or standard definition)
- Unlock time adjustable



AHD  
1080P

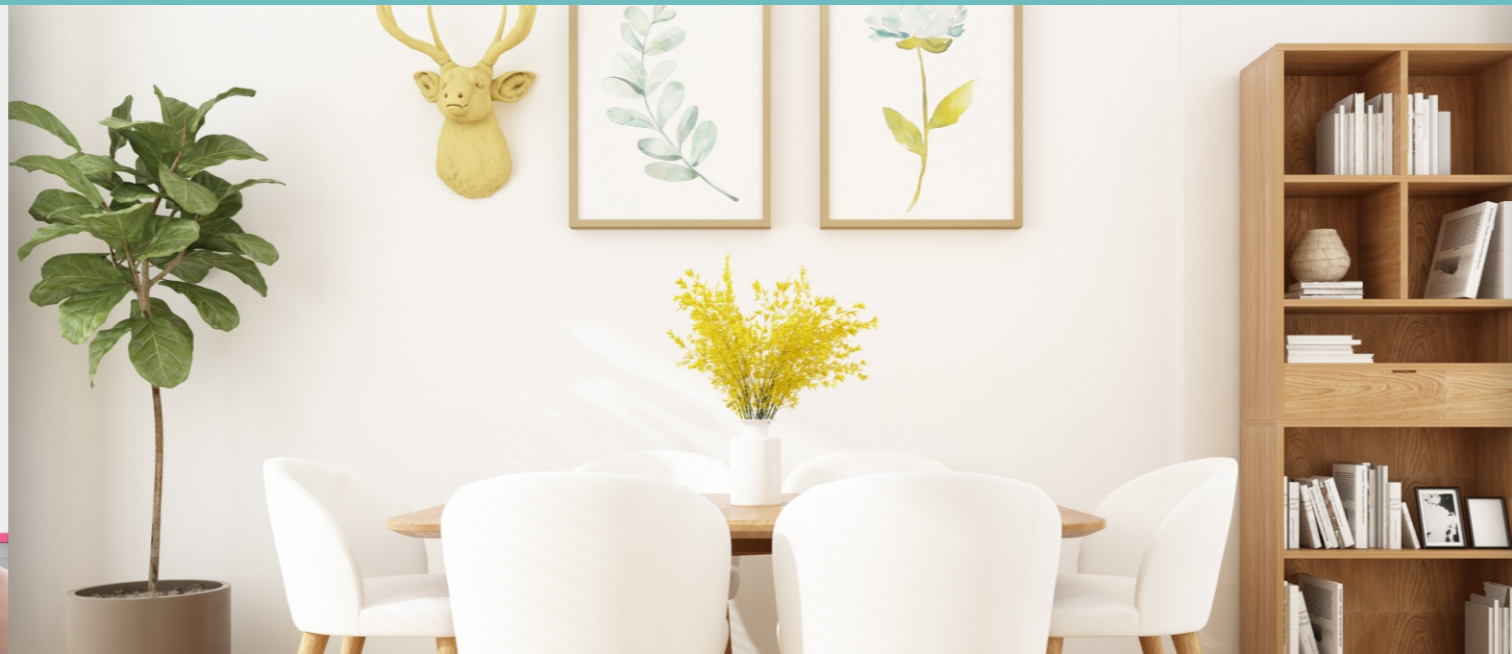

AHD  
1080P

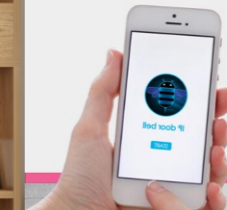

### Model:96707-DP

- ▶ Hands-free Two-way Intercom
- ▶ 7" TFT LCD premier design

Features:



Specification	96707DP
Video	TVI/CVI/CVBS/AHD
Memory	256GB.max. (Within 4090 Pcs file )
Material	Metal
Resolution	1024(H)*600(V)
Power consumption	400mA max.
Power supply	Built in Power supply (AC100-240V) ;DC-12V
Operating temp.	-10°C~ +60°C
Dimension	226*151*23mm
Operation	Sensor Button
Features	
Support Release 3 Locks	Yes
Intercom Mode	Hands-free Two-way Intercom
Conversation duration	120s
Installation	Surface mount
Motion Detection	Yes
Voice Message	Yes
Unlock	Support Mobile Phone and monitor unlock
Digital Zoom	Yes

### Model:96706-DP

- ▶ Hands-free Two-way Intercom
- ▶ 7" TFT LCD premier design

Features:



Specification	96706DP
Video	TVI/CVI/CVBS/AHD
Memory	256GB.max. (Within 4090 Pcs file )
Material	Plastic
Resolution	1024(H)*600(V)
Power consumption	400mA max.
Power supply	Built in Power supply (AC100-240V) ;DC-12V
Operating temp.	-10°C~ +60°C
Dimension	232*144*23.5mm
Operation	Sensor Button
Features	
Support Release 3 Locks	NO
Intercom Mode	Hands-free Two-way Intercom
Conversation duration	120s
Installation	Surface mount
Motion Detection	Yes
Voice Message	Yes
Unlock	Support Mobile Phone and monitor unlock
Digital Zoom	Yes

AHD  
1080P



AHD  
1080P

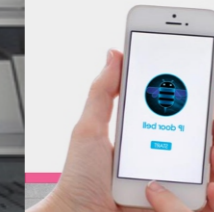
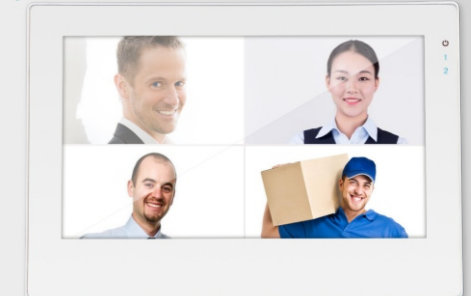

### Model:96103-DP

- ▶ Hands-free Two-way Intercom
- ▶ 10.1" TFT LCD

Features:



Specification	96103DP
Video	TVI/CVI/CVBS/AHD
Memory	256GB.max. (Within 4090 Pcs file )
Material	Metal
Resolution	1024(H)*600(V)
Power consumption	400mA max.
Power supply	Built in Power supply (AC100-240V) ;DC-12V
Operating temp.	-10°C~ +60°C
Dimension	272*182*23mm
Operation	Touch Screen
Features	
Support Release 3 Locks	Yes
Intercom Mode	Hands-free Two-way Intercom
Conversation duration	120s
Installation	Surface mount
Motion Detection	Yes
Voice Message	Yes
Unlock	Support Mobile Phone and monitor unlock
Digital Zoom	Yes

### Model:96703-DP

- ▶ Hands-free Two-way Intercom
- ▶ 7" TFT LCD premier design

Features:

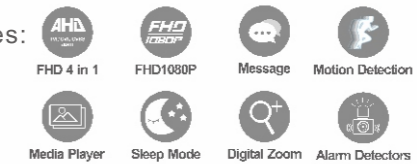

Specification	96703-DP
Video	TVI/CVI/CVBS/AHD
Memory	256GB.max. (Within 4090 Pcs file )
Material	Plastic
Resolution	1024(H)*600(V)
Power consumption	400mA max.
Power supply	Built in Power supply (AC100-240V) ;DC-12V
Operating temp.	-10°C~ +60°C
Dimension	184*126*22.5mm
Operation	Touch Screen
Features	
Support Release 3 Locks	YES
Intercom Mode	Hands-free Two-way Intercom
Conversation duration	120s
Installation	Surface mount
Motion Detection	Yes
Voice Message	Yes
Unlock	Support Mobile Phone and monitor unlock
Digital Zoom	Yes

AHD  
1080P

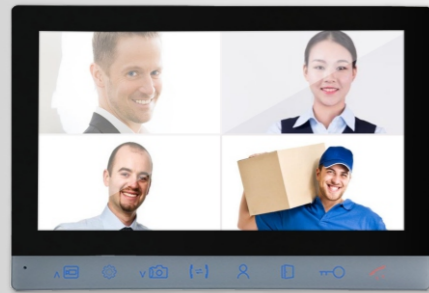

AHD  
1080P



### Model:96110-DP

- ▶ Hands-free Two-way Intercom
- ▶ 10.1" TFT LCD

Features:



Specification	96110DP
Video	TVI/CVI/CVBS/AHD
Memory	256GB.max. (Within 4090 Pcs file )
Material	Plastic
Resolution	1024(H)*600(V)
Power consumption	400mA max.
Power supply	Built in Power supply (AC100-240V) ;DC-12V
Operating temp.	-10°C~ +60°C
Dimension	249*181.5*23mm
Operation	Sensor Button
Features	
Support Release 3 Locks	Yes
Intercom Mode	Hands-free Two-way Intercom
Conversation duration	120s
Installation	Surface mount
Motion Detection	Yes
Voice Message	Yes
Unlock	Support Mobile Phone and monitor unlock
Digital Zoom	Yes

### Model:96701-DP

- ▶ Hands-free Two-way Intercom
- ▶ 7" TFT LCD premier design

Features:



Specification	96701DP
Video	TVI/CVI/CVBS/AHD
Memory	256GB.max. (Within 4090 Pcs file )
Material	Metal
Resolution	1024(H)*600(V)
Power consumption	400mA max.
Power supply	Built in Power supply (AC100-240V) ;DC-12V
Operating temp.	-10°C~ +60°C
Dimension	226*151*23mm
Operation	Sensor Button
Features	
Support Release 3 Locks	YES
Intercom Mode	Hands-free Two-way Intercom
Conversation duration	120s
Installation	Surface mount
Motion Detection	Yes
Voice Message	Yes
Unlock	Support Mobile Phone and monitor unlock
Digital Zoom	Yes



- ▶ Support Play movie and Music or Clock during standby mode
- ▶ Support Choose MP3 Ringtone
- ▶ Support Photo Frame
- ▶ Support photo capture and video recording
- ▶ Support Point to point transfer and Internal call
- ▶ Adjustable brightness ,Contrast ,Ring volume and speaker volume
- ▶ Adjustable monitoring time from 120s-180s-240s-300s-ON all the time
- ▶ Up to 6 monitor and 2 doorbells and 2 CCTV cameras  
(AHD Or standard definition)
- ▶ Unlock time adjustable

## AHD/Analog Video Door Phone ▶





**Model:94110**

- ▶ Hands-free Two-way Intercom
- ▶ 10.1" TFT LCD premier design

Features:

- FHD 4 in 1
- FHD1080P
- Message
- Motion Detection
- Media Player
- Sleep Mode
- Digital Zoom
- Alarm Detectors

Specification	94110-HP	94110-AP	94110-AP
Video	TVI/CVI/CVBS/AHD	AHD/CVBS	AHD/CVBS
Memory	128GB.max.	32GB.max.	32GB.max.
Material	Plastic		
Resolution	1024(H)*600(V)		
Power consumption	400mA max.		
Power supply	Built in Power supply (AC100-240V) ;DC-12V		
Operating temp.	-10°C~+60°C		
Dimension	249*181.5*23mm		
Operation	Sensor Button		
Features			
Support Release 3 Locks	YES		
Digital Zoom	YES	YES	NO
Conversation duration	120s		
Installation	Surface mount		
Motion Detection	YES		
Voice Message	YES		



**Model:94103**

- ▶ Hands-free Two-way Intercom
- ▶ 10.1" TFT LCD premier design

Features:

- FHD 4 in 1
- FHD1080P
- Message
- Motion Detection
- Media Player
- Sleep Mode
- Digital Zoom
- Alarm Detectors
- Touch screen

Specification	94103-HP	94103-AP	94103-MP
Video	TVI/CVI/CVBS/AHD	AHD/CVBS	AHD/CVBS
Memory	128GB.max.	32GB.max.	32GB.max.
Material	Metal		
Resolution	1024(H)*600(V)		
Power consumption	400mA max.		
Power supply	Built in Power supply (AC100-240V) ;DC-12V		
Operating temp.	-10°C~+60°C		
Dimension	272*182*23mm		
Operation	Touch Screen		
Features			
Support Release 3 Locks	YES		
Digital Zoom	YES	YES	NO
Conversation duration	120s		
Installation	Surface mount		
Motion Detection	YES		
Voice Message	YES		

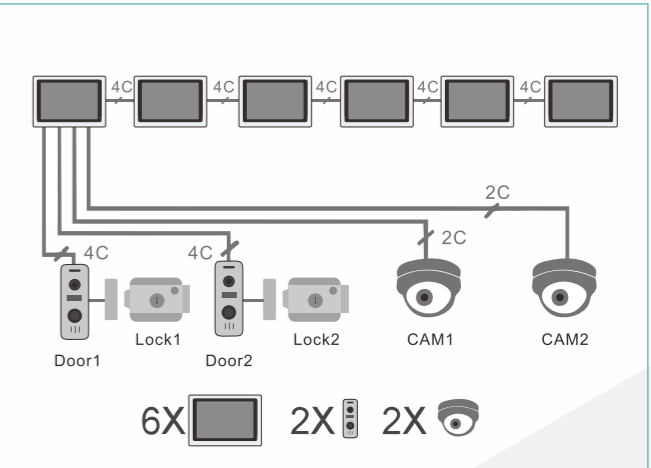
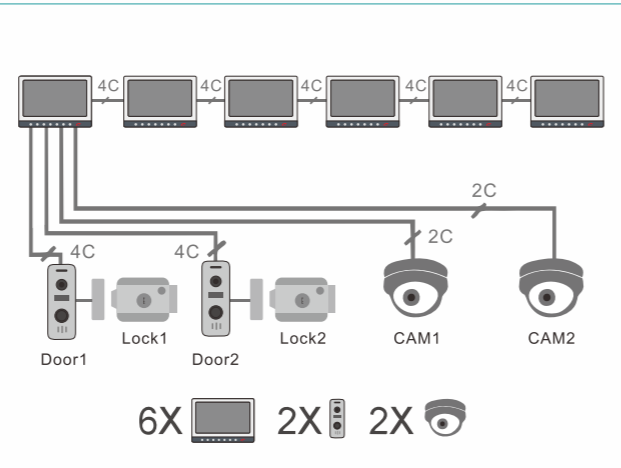





**Model:94107**

- ▶ Hands-free Two-way Intercom
- ▶ 10.1" TFT LCD premier design

Features:

- FHD 4 in 1
- FHD1080P
- Message
- Motion Detection
- Media Player
- Sleep Mode
- Digital Zoom
- Alarm Detectors

Specification	94107-HP	94107-AP	94107-MP
Video	TVI/CVI/CVBS/AHD	AHD/CVBS	AHD/CVBS
Memory	128GB.max.	32GB.max.	32GB.max.
Material	Metal		
Resolution	1024(H)*600(V)		
Power consumption	400mA max.		
Power supply	Built in Power supply (AC100-240V) ;DC-12V		
Operating temp.	-10°C~+60°C		
Dimension	272.5*194*23.5mm		
Operation	Sensor Button		
Features			
Support Release 3 Locks	YES		
Digital Zoom	YES	YES	NO
Conversation duration	120s		
Installation	Surface mount		
Motion Detection	YES		
Voice Message	YES		



**Model:94102**

- ▶ Hands-free Two-way Intercom
- ▶ 10.1" TFT LCD premier design

Features:

- FHD 4 in 1
- FHD1080P
- Message
- Motion Detection
- Media Player
- Sleep Mode
- Digital Zoom
- Alarm Detectors

Specification	94102-HP	94102-AP	94102-MP
Video	TVI/CVI/CVBS/AHD	AHD/CVBS	AHD/CVBS
Memory	128GB.max.	32GB.max.	32GB.max.
Material	Metal		
Resolution	1024(H)*600(V)		
Power consumption	400mA max.		
Power supply	Built in Power supply (AC100-240V) ;DC-12V		
Operating temp.	-10°C~+60°C		
Dimension	272.5*194*23.5mm		
Operation	Sensor Button		
Features			
Support Release 3 Locks	YES		
Digital Zoom	YES	YES	NO
Conversation duration	120s		
Installation	Surface mount		
Motion Detection	YES		
Voice Message	YES		

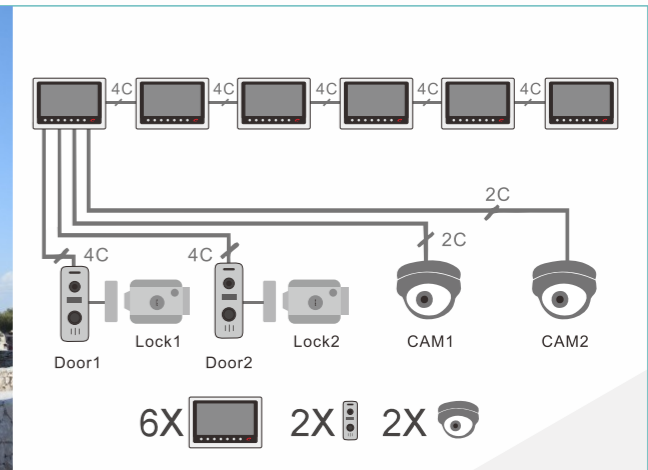
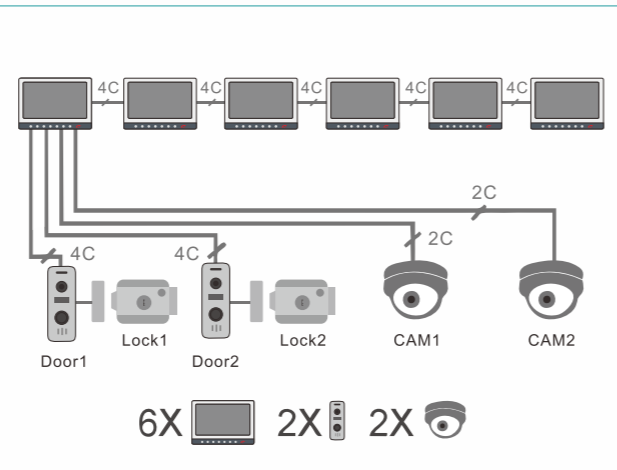



**Model:94101**

- ▶ Hands-free Two-way Intercom
- ▶ 10.1" TFT LCD premier design

Features:

- FHD 4 in 1
- FHD1080P
- Message
- Motion Detection
- Media Player
- Sleep Mode
- Digital Zoom
- Alarm Detectors

Specification	94101-HP	94101-AP	94101-MP
Video	TVI/CVI/CVBS/AHD	AHD/CVBS	AHD/CVBS
Memory	128GB.max.	32GB.max.	32GB.max.
Material	Metal		
Resolution	1024(H)*600(V)		
Power consumption	400mA max.		
Power supply	Built in Power supply (AC100-240V) ;DC-12V		
Operating temp.	-10°C~+60°C		
Dimension	284*194*23.5mm		
Operation	Sensor Button		
Features			
Support Release 3 Locks	YES		
Digital Zoom	YES	YES	No
Conversation duration	120s		
Installation	Surface mount		
Motion Detection	YES		
Voice Message	YES		



**Model:94711**

- ▶ Handset Two-way Intercom
- ▶ 7" TFT LCD premier design

Features:

- FHD 4 in 1
- FHD1080P
- Message
- Motion Detection
- Media Player
- Sleep Mode
- Digital Zoom
- Alarm Detectors

Specification	94711-HP	94711-AP	94711-MP
Video	TVI/CVI/CVBS/AHD	AHD/CVBS	AHD/CVBS
Memory	128GB.max.	32GB.max.	32GB.max.
Material	Plastic		
Resolution	1024(H)*600(V)		
Power consumption	400mA max.		
Power supply	Built in Power supply (AC100-240V) ;DC-12V		
Operating temp.	-10°C~+60°C		
Dimension	246*120*20mm		
Operation	Sensor Button		
Features			
Support Release 3 Locks	NO		
Digital Zoom	YES	YES	NO
Conversation duration	120s		
Installation	Surface mount		
Motion Detection	YES		
Voice Message	YES		

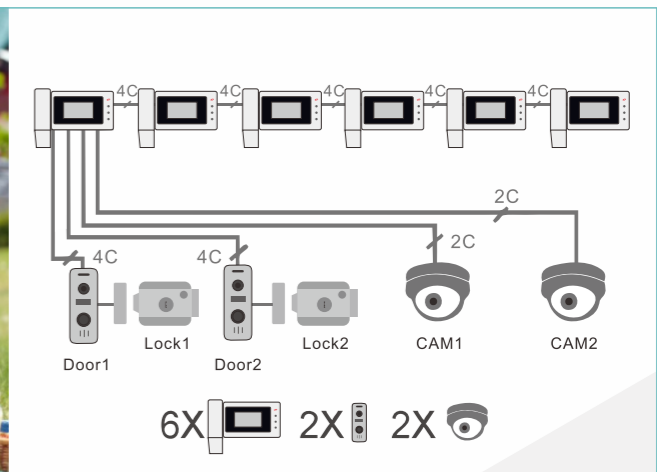
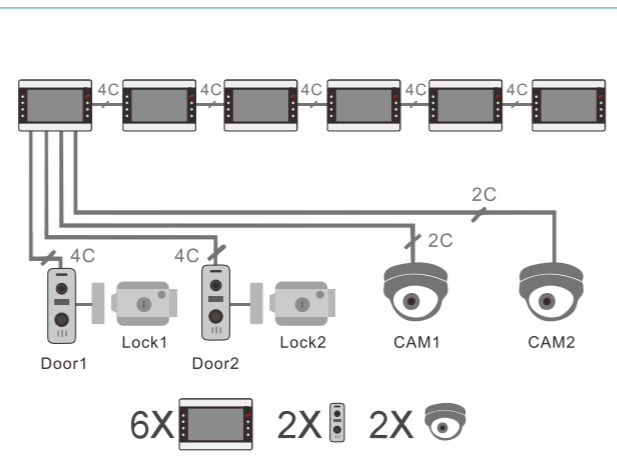



**Model:94710**

- ▶ Hands-free Two-way Intercom
- ▶ 7" TFT LCD premier design

Features:

- FHD 4 in 1
- FHD1080P
- Message
- Motion Detection
- Media Player
- Sleep Mode
- Digital Zoom
- Alarm Detectors

Specification	94710-HP	94710-AP	94710-AP
Video	TVI/CVI/CVBS/AHD	AHD/CVBS	AHD/CVBS
Memory	128GB.max.	32GB.max.	32GB.max.
Material	Plastic		
Resolution	1024(H)*600(V)		
Power consumption	400mA max.		
Power supply	Built in Power supply (AC100-240V) ;DC-12V		
Operating temp.	-10°C~+60°C		
Dimension	175.5*122.5*21.5mm		
Operation	Sensor Button		
Features			
Support Release 3 Locks	YES		
Digital Zoom	YES	YES	NO
Conversation duration	120s		
Installation	Surface mount		
Motion Detection	YES		
Voice Message	YES		



**Model:94708**

- ▶ Hands-free Two-way Intercom
- ▶ 7" TFT LCD premier design

Features:

- FHD 4 in 1
- FHD1080P
- Message
- Motion Detection
- Media Player
- Sleep Mode
- Digital Zoom
- Alarm Detectors

Specification	94708-HP	94708-AP	94708-MP
Video	TVI/CVI/CVBS/AHD	AHD/CVBS	AHD/CVBS
Memory	128GB.max.	32GB.max.	32GB.max.
Material	Plastic		
Resolution	1024(H)*600(V)		
Power consumption	400mA max.		
Power supply	Built in Power supply (AC100-240V) ;DC-12V		
Operating temp.	-10°C~+60°C		
Dimension	184*126*22.5mm		
Operation	Sensor Button		
Features			
Support Release 3 Locks	YES		
Digital Zoom	YES	YES	NO
Conversation duration	120s		
Installation	Surface mount		
Motion Detection	YES		
Voice Message	YES		

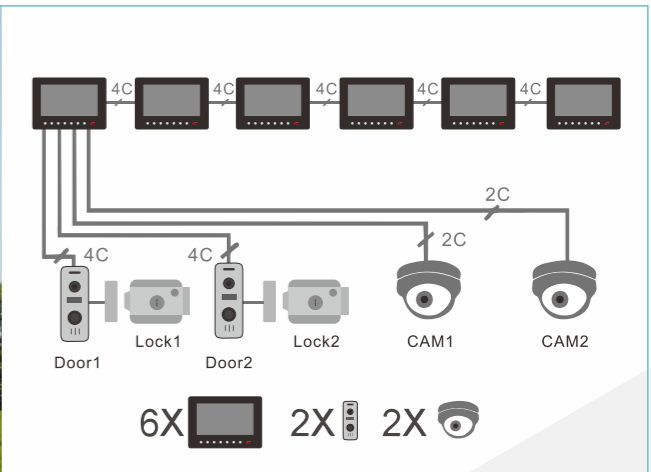
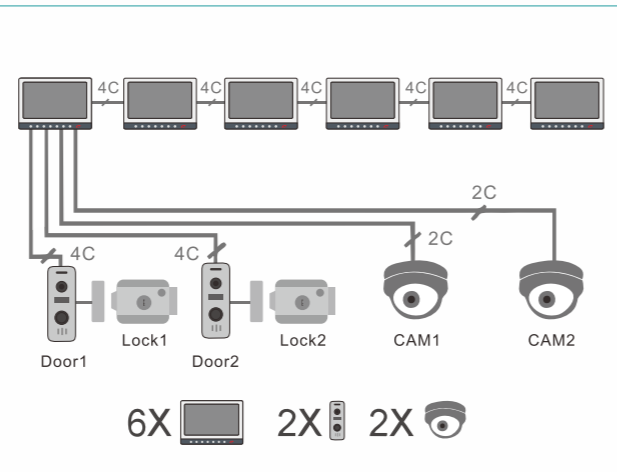



**Model:94707**

- ▶ Hands-free Two-way Intercom
- ▶ 7" TFT LCD premier design

Features:

- FHD 4 in 1
- FHD1080P
- Message
- Motion Detection
- Media Player
- Sleep Mode
- Digital Zoom
- Alarm Detectors

Specification	94707-HP	94707-AP	94707-MP
Video	TVI/CVI/CVBS/AHD	AHD/CVBS	AHD/CVBS
Memory	128GB.max.	32GB.max.	32GB.max.
Material	Metal		
Resolution	1024(H)*600(V)		
Power consumption	400mA max.		
Power supply	Built in Power supply (AC100-240V) ;DC-12V		
Operating temp.	-10°C~+60°C		
Dimension	226*151*23mm		
Operation	Sensor Button		
Features			
Support Release 3 Locks	YES		
Digital Zoom	YES	YES	NO
Conversation duration	120s		
Installation	Surface mount		
Motion Detection	YES		
Voice Message	YES		



**Model:94706**

- ▶ Hands-free Two-way Intercom
- ▶ 7" TFT LCD premier design

Features:

- FHD 4 in 1
- FHD1080P
- Message
- Motion Detection
- Media Player
- Sleep Mode
- Digital Zoom
- Alarm Detectors

Specification	94706-HP	94706-AP	94706-MP
Video	TVI/CVI/CVBS/AHD	AHD/CVBS	AHD/CVBS
Memory	128GB.max.	32GB.max.	32GB.max.
Material	Plastic		
Resolution	1024(H)*600(V)		
Power consumption	400mA max.		
Power supply	Built in Power supply (AC100-240V) ;DC-12V		
Operating temp.	-10°C~+60°C		
Dimension	232*144*23.5mm		
Operation	Sensor Button		
Features			
Support Release 3 Locks	NO		
Digital Zoom	YES	YES	NO
Conversation duration	120s		
Installation	Surface mount		
Motion Detection	YES		
Voice Message	YES		

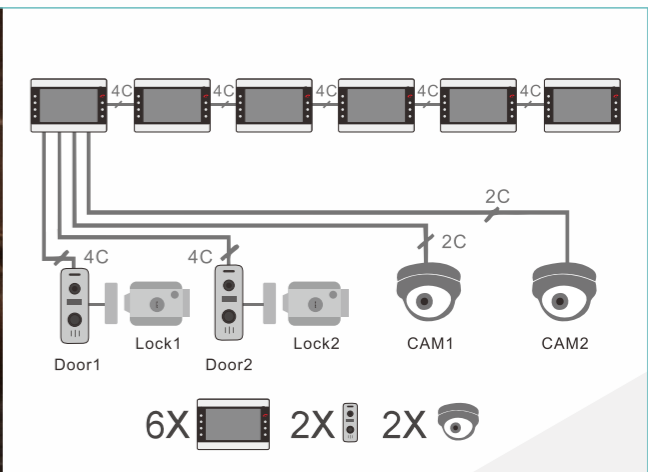
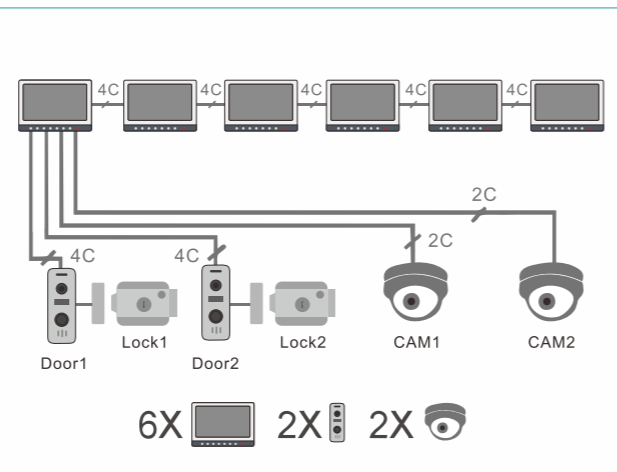

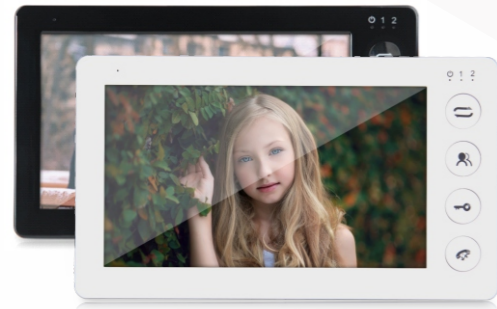

**Model:94705**

- ▶ Hands-free Two-way Intercom
- ▶ 7" TFT LCD premier design

Features:

- FHD 4 in 1
- FHD1080P
- Message
- Motion Detection
- Media Player
- Sleep Mode
- Digital Zoom
- Alarm Detectors

Specification	94705-HP	94705-AP	94705-MP
Video	TVI/CVI/CVBS/AHD	AHD/CVBS	AHD/CVBS
Memory	128GB.max.	32GB.max.	32GB.max.
Material	Plastic		
Resolution	1024(H)*600(V)		
Power consumption	400mA max.		
Power supply	Built in Power supply (AC100-240V) ;DC-12V		
Operating temp.	-10°C~+60°C		
Dimension	207*117*23mm		
Operation	Manual Button		
Features			
Support Release 3 Locks	NO		
Digital Zoom	YES	YES	NO
Conversation duration	120s		
Installation	Surface mount		
Motion Detection	YES		
Voice Message	YES		



**Model:94703**

- ▶ Hands-free Two-way Intercom
- ▶ 7" TFT LCD premier design

Features:

- FHD 4 in 1
- FHD1080P
- Message
- Motion Detection
- Media Player
- Sleep Mode
- Digital Zoom
- Alarm Detectors
- Touch screen

Specification	94703-HP	94703-AP	94708-MP
Video	TVI/CVI/CVBS/AHD	AHD/CVBS	AHD/CVBS
Memory	128GB.max.	32GB.max.	32GB.max.
Material	Plastic		
Resolution	1024(H)*600(V)		
Power consumption	400mA max.		
Power supply	Built in Power supply (AC100-240V) ;DC-12V		
Operating temp.	-10°C~+60°C		
Dimension	184*126*22.5mm		
Operation	Touch Screen		
Features			
Support Release 3 Locks	YES		
Digital Zoom	YES	YES	NO
Conversation duration	120s		
Installation	Surface mount		
Motion Detection	YES		
Voice Message	YES		

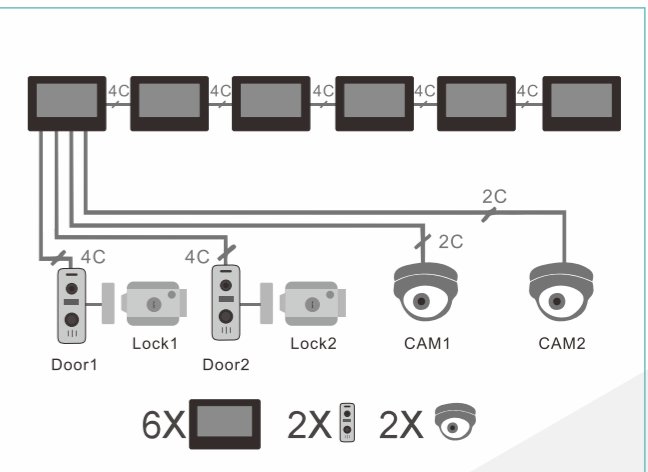
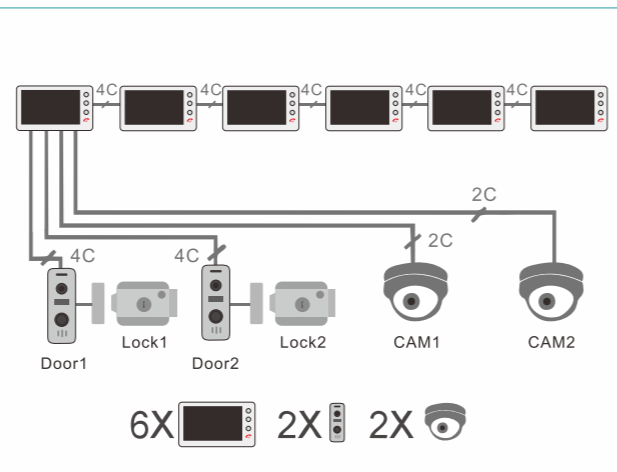



**Model:94703-Mirror**

- ▶ Hands-free Two-way Intercom
- ▶ 7" TFT LCD premier design

Features:

- FHD 4 in 1
- FHD1080P
- Message
- Motion Detection
- Media Player
- Sleep Mode
- Digital Zoom
- Alarm Detectors
- Touch screen

Specification	94703-HP	94703-AP	94703-MP
Video	TVI/CVI/CVBS/AHD	AHD/CVBS	AHD/CVBS
Memory	128GB.max.	32GB.max.	32GB.max.
Material	Plastic		
Resolution	1024(H)*600(V)		
Power consumption	400mA max.		
Power supply	Built in Power supply (AC100-240V) ;DC-12V		
Operating temp.	-10°C~+60°C		
Dimension	184*126*22.5mm		
Operation	Touch Screen		
Features			
Support Release 3 Locks	YES		
Digital Zoom	YES	YES	NO
Conversation duration	120s		
Installation	Surface mount		
Motion Detection	YES		
Voice Message	YES		

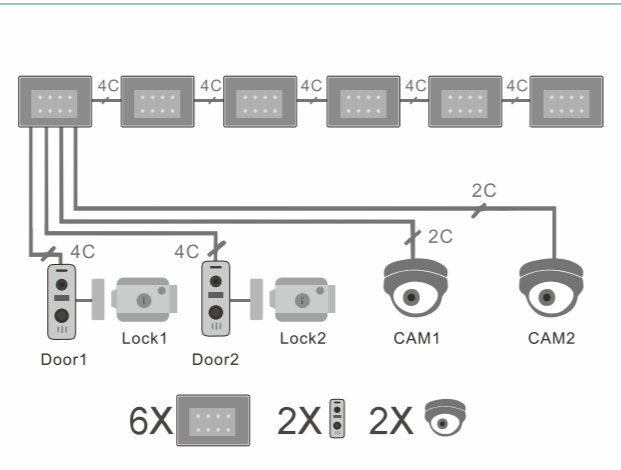

**Model:94701**

- ▶ Hands-free Two-way Intercom
- ▶ 7" TFT LCD premier design

Features:

- FHD 4 in 1
- FHD1080P
- Message
- Motion Detection
- Media Player
- Sleep Mode
- Digital Zoom
- Alarm Detectors

Specification	94701-HP	94701-AP	94701-MP
Video	TVI/CVI/CVBS/AHD	AHD/CVBS	AHD/CVBS
Memory	128GB.max.	32GB.max.	32GB.max.
Material	Metal		
Resolution	1024(H)*600(V)		
Power consumption	400mA max.		
Power supply	Built in Power supply (AC100-240V) ;DC-12V		
Operating temp.	-10°C~+60°C		
Dimension	226*151*23mm		
Operation	Sensor Button		
Features			
Support Release 3 Locks	YES		
Digital Zoom	YES	YES	NO
Conversation duration	120s		
Installation	Surface mount		
Motion Detection	YES		
Voice Message	YES		

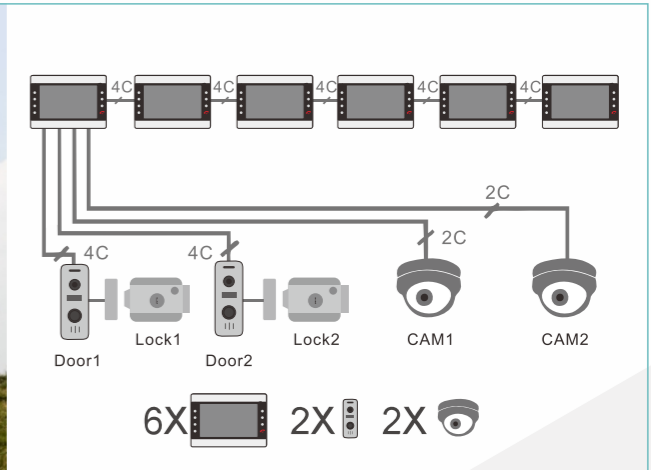



**Model:94401**

- ▶ Hands-free Two-way Intercom
- ▶ 4.3" TFT LCD premier design

Specification	94401-AP
Video	AHD/CVBS
Memory	32GB.max.
Material	Plastic
Resolution	320 (H)*272(V)
Power consumption	400mA max.
Power supply	Built in Power supply (AC100-240V) ;DC-12V
Operating temp.	-10°C~+60°C
Dimension	169*121*23mm
Operation	Sensor Button
Features	
Support Release 3 Locks	NO
Digital Zoom	YES
Conversation duration	120s
Installation	Surface mount
Motion Detection	YES
Voice Message	YES

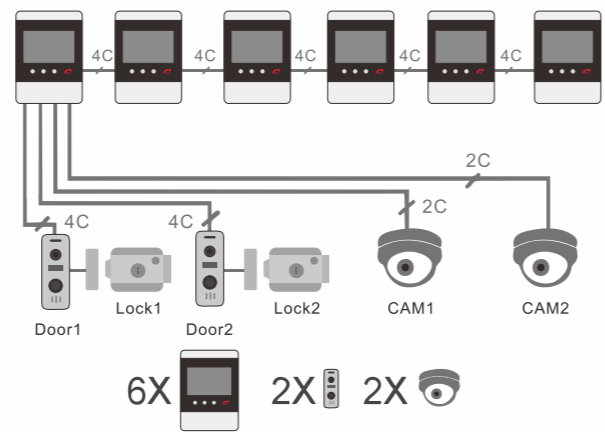

**Model:94402**

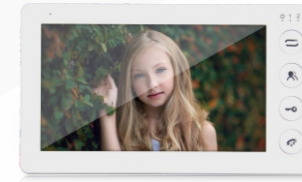

**Model:94705**

**Model:94411**



**Model:94711**



Specification	94402-EP	94705-EP	94411-EP	94711-EP
Display	4.3" TFT LCD	7" TFT LCD	4.3" TFT LCD	7" TFT LCD
Resolution	320 (H)*272(V)	800(H) *480(V)	320 (H)*272(V)	800(H) *480(V)
Operation	Manual Button	Manual Button	Sensor Button	Sensor Button
Dimension	122*170*21.5mm	207*117*23mm	246*120*20mm	246*120*20mm
Power supply	Built in Power supply (AC100-240V) ;DC-12V			
Intercom Mode	Hands-free Two-way Intercom		with handset	
Video	CVBS			
Material	Plastic			
Power consumption	400mA max.			
Operating temp.	-10°C~+60°C			
Conversation duration	120s			
Installation	Surface mount			

- ▶ Support 2 call panel+4 indoor monitor ▶ Support Point to point transfer and Internal call
- ▶ Unlock time adjustable ▶ Adjustable brightness ,Contrast ,Ring volume and speaker volume

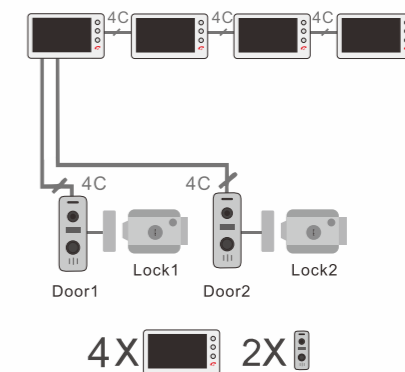



# AHD1080P Outdoor Bell ▶

AHD  
1080P



Specification	
Model	94206-AHD1080P
Definition	1080P(2MP)
View Angle	160°
LEDs for night	IR LEDs(120°)
IR Cut	YES
Power consumption	200mA Max.
Power supplier	Supplied from Indoor monitor
Operation temp.	-40°C~ +60°C
Installation	Surface
Size	133x48x21mm

### Features:

- Support 1080P/960P/720P/CVBS resolution
- Support IR-Cut
- Able to switch the output mode between 1080P-720P-CVBS
- Wide angle camera
- Anti-oxidation aluminium alloy panel
- Simple 4-wire connection
- Waterproof IP65
- IR LED illumination for better night vision
- Able to connect with Exit button
- Multiple color optional



AHD  
1080P



### Model:94206-C-AHD1080P

#### Features:

- ▶ Support 1080P/960P/720P/CVBS resolution
- ▶ Support IR-Cut
- ▶ Support 200IC card
- ▶ Able to switch the output mode between 1080P-720P-CVBS
- ▶ Wide angle camera
- ▶ Anti-oxidation aluminium alloy panel
- ▶ Simple 4-wire connection
- ▶ Waterproof IP65
- ▶ IR LED illumination for better night vision
- ▶ Able to connect with Exit button
- ▶ Keypad with white LED backlight for night operation
- ▶ Black & White color optional

Specification	94206-C-AHD1080P
Definition	1080P(2MP)
View Angle	160°
LEDs for night	IR LEDs(120°)
IR Cut	YES
Power consumption	200mA Max.
Power supplier	Supplied from Indoor monitor
Operation temp.	-40°C~ +60°C
Installation	Surface
Size	133x48x21mm





**AHD  
1080P**

**AHD  
1080P**



**Model:94214-AHD1080P**

**Features:**

- ▶ Support 1080P/960P/720P/CVBS resolution
- ▶ Support IR-Cut
- ▶ Support 200IC card
- ▶ Support 200 Password
- ▶ Able to switch the output mode between 1080P-720P-CVBS
- ▶ Wide angle camera
- ▶ Anti-oxidation aluminium alloy panel
- ▶ Simple 4-wire connection
- ▶ Waterproof IP65
- ▶ IR LED illumination for better night vision
- ▶ Able to connect with Exit button
- ▶ Keypad with white LED backlight for night operation
- ▶ Black & White color optional

Specification	94214-AHD1080P
Definition	1080P(2MP)
View Angle	140°
LEDs for night	IR LEDs(120°)
IR Cut	YES
Power consumption	200mA Max.
Power supplier	Supplied from Indoor monitor
Operation temp.	-40°C~ +60°C
Installation	Surface
Size	140*90*27mm



**Model:94202-AHD1080P**

**Features:**

- ▶ Support 1080P/960P/720P/CVBS resolution
- ▶ Support IR-Cut
- ▶ Able to switch the output mode between 1080P-720P-CVBS
- ▶ Wide angle camera
- ▶ Anti-oxidation aluminium alloy panel
- ▶ Simple 4-wire connection
- ▶ Waterproof IP65
- ▶ Able to connect with Exit button
- ▶ IR LED illumination for better night vision

Specification	94202-AHD1080P
Definition	1080P(2MP)
View Angle	160°
LEDs for night	IR LEDs(120°)
IR Cut	YES
Power consumption	200mA Max.
Power supplier	Supplied from Indoor monitor
Operation temp.	-40°C~ +60°C
Installation	Surface
Size	131x51x41mm



**Model:94203-AHD1080P**
**Features:**

- ▶ Support 1080P/960P/720P/CVBS resolution
- ▶ Support IR-Cut
- ▶ Able to switch the output mode between 1080P-720P-CVBS
- ▶ Pinhole camera
- ▶ Anti-oxidation aluminium alloy panel
- ▶ Simple 4-wire connection
- ▶ Waterproof IP65
- ▶ Able to connect with Exit button
- ▶ IR LED illumination for better night vision

Specification	94203-AHD1080P
Definition	1080P(2MP)
View Angle	95°
LEDs for night	IR LEDs(120°)
IR Cut	YES
Power consumption	200mA Max.
Power supplier	Supplied from Indoor monitor
Operation temp.	-40°C~ +60°C
Installation	Surface
Size	131x51x41mm

**Model:94204-AHD1080P**
**Features:**

- ▶ Support 1080P/960P/720P/CVBS resolution
- ▶ Support IR-Cut
- ▶ Able to switch the output mode between 1080P-720P-CVBS
- ▶ Pinhole camera
- ▶ Anti-oxidation aluminium alloy panel
- ▶ Simple 4-wire connection
- ▶ Waterproof IP65
- ▶ Able to connect with Exit button
- ▶ IR LED illumination for better night vision

Specification	94204-AHD1080P
Definition	1080P(2MP)
View Angle	95°
LEDs for night	IR LEDs(120°)
IR Cut	YES
Power consumption	200mA Max.
Power supplier	Supplied from Indoor monitor
Operation temp.	-40°C~ +60°C
Installation	Surface
Size	131x51x41mm



**AHD  
1080P**

**AHD  
1080P**



**Model:94201-AHD1080P**

**Features:**

- ▶ Support 1080P/960P/720P/CVBS resolution
- ▶ Support IR-Cut
- ▶ Able to switch the output mode between 1080P-720P-CVBS
- ▶ Pinhole camera
- ▶ Anti-oxidation aluminium alloy panel
- ▶ Simple 4-wire connection
- ▶ Waterproof Ip65
- ▶ IR LED illumination for better night vision
- ▶ Able to connect with Exit button

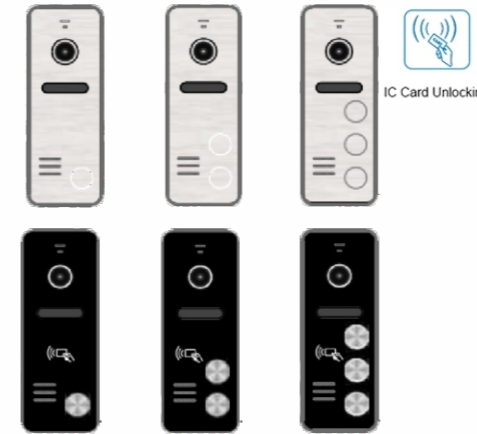

**Model:94207-C-AHD1080P**

**Features:**

- ▶ Support 1080P/960P/720P/CVBS resolution
- ▶ Support IR-Cut
- ▶ Support 200IC card
- ▶ Able to switch the output mode between 1080P-720P-CVBS
- ▶ Wide angle camera
- ▶ Anti-oxidation aluminium alloy panel
- ▶ Simple 4-wire connection
- ▶ Waterproof IP65
- ▶ IR LED illumination for better night vision
- ▶ Able to connect with Exit button
- ▶ Keypad with white LED backlight for night operation
- ▶ Black & White color optional
- ▶ Support one/two/three family use

Specification	94201-AHD1080P
Definition	1080P(2MP)
View Angle	95°
LEDs for night	IR LEDs(120°)
IR Cut	YES
Power consumption	200mA Max.
Power supplier	Supplied from Indoor monitor
Operation temp.	-40°C~ +60°C
Installation	Surface
Size	131x51x41mm

Specification	94207-C-AHD1080P
Definition	1080P(2MP)
View Angle	160°
LEDs for night	IR LEDs(120°)
IR Cut	YES
Power consumption	200mA Max.
Power supplier	Supplied from Indoor monitor
Operation temp.	-40°C~ +60°C
Installation	Surface
Size	133x48x21mm





## Outdoor Bell

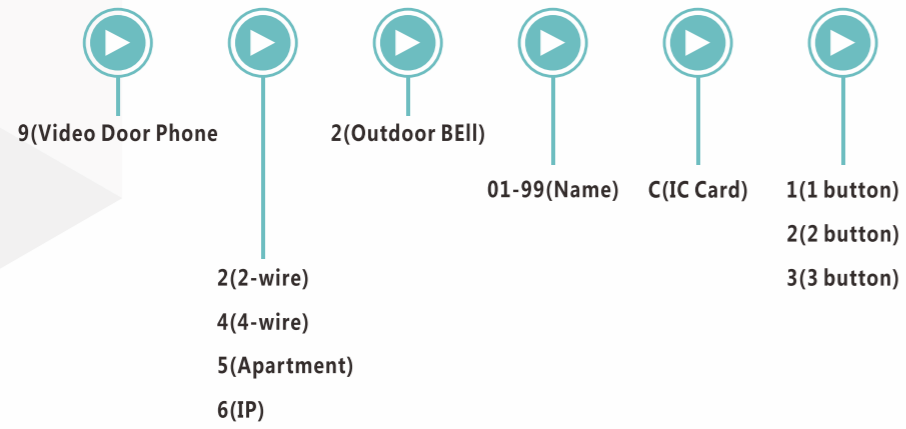

## Indoor Monitor

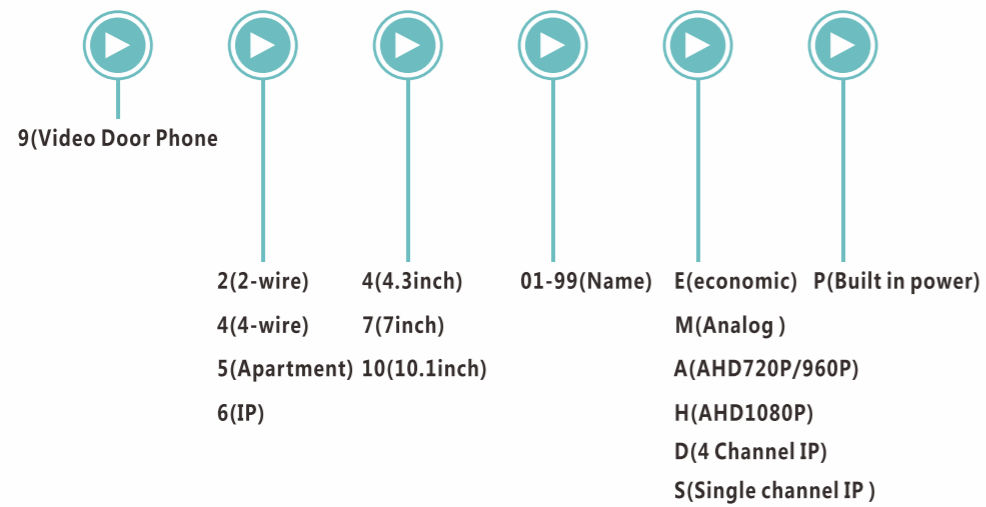

# FHD VIDEO DOOR PHONE

Morning Technology Co.,Ltd