

F I R E
DETECTION
2 0 1 8

Deep roots, global vision.

Founded in 1956, Comelit Group SpA is an industrial company operating on a worldwide scale and specialising in the design and manufacture of video entry, video surveillance, anti-intrusion, home automation and access control systems. The company has a strong international vocation thanks to its close ties with the area in which it was created and in which its headquarters are still located today.

An international group.

Comelit exports to over 70 countries worldwide and, in addition to its Italian headquarters, has 15 branches located in strategic areas in which the company operates: from Europe to the Far East, the United States and the Middle East. This articulated sales structure integrates shared know-how with the awareness of specific requirements in each market.

Constant innovation, friendly technology.

Comelit constantly makes looking to the future its mission. Innovation through continuous investment in manpower and technology finds an outlet in the design of new solutions dedicated to improving the quality of everyday life by maximising simplicity and functionality.

Design: style, passion, art.

Besides placing technology at the service of mankind, Comelit is also a byword for design. Its unique and original style combines the most hi-tech materials with simple lines, clean shapes and cutting-edge colours. Every Comelit product therefore conveys a new concept for living in a space, in harmony with modern architectural trends.

D E S I G N
M I L A N O



Merlion Awards



DESIGN PLUS
powered by light+building



 **Comelit**[®]
Passion. Technology. Design.

FIRE DETECTION SOLUTIONS

APPLICATIONS AND SYSTEMS	4
OUR CALCULATION TOOLS	6
ASPIRATING SMOKE DETECTION SYSTEMS	8
BEAM DETECTORS	10
ATEX SYSTEM	12
ATENA MANAGER SUPERVISION SOFTWARE	14
APPLICATION EXAMPLES	16
APPLICATION DIAGRAMS	20

PRODUCT CATALOGUE	26
--------------------------	-----------

FIRE DETECTION





FIRE DETECTION SOLUTIONS

GUIDE TO FIRE DETECTION

APPLICATIONS



AIRPORTS



HOSPITALS



SCHOOLS



OFFICES



MUSEUMS



HOTELS



SHOPPING CENTRES



CAR PARKS



INDUSTRIES

THE SYSTEMS



Conventional systems are particularly suited to fire detection in smaller facilities and buildings with simple layouts. These systems require the installation of detectors and manual call points in separate 2-wire zones, with a maximum of 32 devices per zone.



Addressable systems can identify the precise location of a fire and are suitable for facilities of all types. Each loop of an addressable control panel can include up to 250 devices.



Aspirating smoke detection systems are used in combination with an addressable system and are the ideal substitute for point detectors in situations where access and maintenance are difficult.



ATEX systems are used in reference to zones where there is risk of explosion due to the nature of atmosphere and the elements it contains.

SYSTEM COMPARISON

	CONVENTIONAL SYSTEM	ADDRESSABLE SYSTEM
Product codes	43CPC002EN - 43CPC004EN 43CPC008EN - 43CPC016EN	41CPE012 - 41CPE024EN
Certification	EN54-2, EN54-4	EN54-2, EN54-4, LPCB
Possibility for connecting with Comelit aspiration system	No	Yes
Programming via PC software	No	Yes
Identification of the specific device triggering the fire alarm or fault	No	Yes
Connection of multiple control panels in a network	No	Yes
Supervision via software on a PC	No	Yes
Maximum number of devices per zone/loop	32	250
Separate cabling required for manual call point and detectors	Yes	No
Timer programming for day/night mode	No	Yes
Access level protection	Via mechanical key	Via numeric code
Events log	No	Yes
RECOMMENDED APPLICATIONS		
Offices	Yes	Yes
Car parks	Yes	Yes
Museums	Yes	Yes
Airports	No	Yes
Shopping centres	No	Yes
Hotels	No	Yes
Schools	No	Yes



FIRE DETECTION SOLUTIONS

GUIDE TO FIRE DETECTION

OUR CALCULATION TOOLS

Comelit provides tools that can correctly calculate the dimensions of addressable systems and precisely identify any possible problems before installation of the system. For example, you can calculate the cross-section and maximum length of the cable to use in accordance with the devices installed in the system, the maximum current consumption of the devices and thereby determine whether the control panel will be able to control them. A second tool calculates the minimum capacity of the battery to be installed to ensure a certain level of autonomous operation in the event of a mains power outage. All this is possible simply by entering the number of devices that are to be installed. There are 3 calculation tools available:

- Tool for calculating cable cross-section and length and the current consumption for all Comelit addressable control panels.
- Battery calculator for the Atena addressable control panel
- Battery calculator for the Atena Easy addressable control panel

Below is a simple example of how to use these calculation tools.

Example system with the devices listed in the following table.

Product codes	DESCRIPTION	QUANTITY
41RCS000	Addressable heat detector	5
41RFU000	Addressable optical smoke detector	30
41RML000	Addressable multi-criteria detector	10
41PAM000	Addressable manual call point	5
41SAI000	Addressable siren	5
41SCI000	Addressable siren and strobe	3
41SAB000	Base with addressable siren	2
41IOM022	Addressable 2IN / 2OUT module	3

Using the tool for calculation of cable characteristics and current consumption for Atena and Atena Easy, entering the data gives the following results:

- Current consumption = 213.4 mA
- Maximum cable length using cable with cross-section 1.5mm² = 4174.6m
- Minimum cable cross-section, given maximum length of loop is, for example, 2500m = 1mm²

Using the battery calculation programme, assuming a 40 hour stand-by time and 30 minutes

with 2 x 41RFU000, 2 x 41SAI000 and 1 x 41SCI000 in alarm condition, entering the above data gives the following results:

- Minimum battery capacity required = 20.3 Ah
- Maximum current consumption in stand-by = 0.15 A
- Maximum current consumption in alarm state = 0.3 A

COMELIT CALCULATION SOFTWARE EXAMPLE

1. Insert the number of the loops (1-4):

2. Insert the number of the devices for each loop:

Stand-by	Loop			
	1	2	3	4
Detectors				
41RCS000				
41RFU000				
41RML000				
41PAM000				
Sirens				
41SAB000				
41SAI000				
41SC000				
Modules				
41IOM122 2I / 20				
41IOM004 4 Output				
41IOM040 4 Input				
41ISC000 Supplied by loop				
41ISC000 Ext. Supplied				
41IOM000 Supervised Output				
41IOM010 Miniaturized Input				
Accessories				
41ISL000 Isolators*				
48FPT000 Remot LED indicators*				

* Note: The devices 41ISL000 and 48FPT000 are not addressable.

3. Insert the parameters of the panel:

Output	Stand-by	Alarm
FIRE R (0-0.3 A)		
FIRE P (0-0.3 A)		
FAULT R (0-0.3 A)		
SND 1/2 (0-0.3 A)		
AUX +24V (0-3A)		
Relay (0-4)		

Calculate

Min. necessary capacity of the battery (Ah):

4. Insert the number of zones in alarm (1-96):

5. Insert the hours of working time in stand-by mode to guarantee in case of absence of power supply:

6. Insert the hours of working time in alarm mode to guarantee in case of absence of power supply:

Max. current consumption in stand-by (A):			
Loop 1	Loop 2	Loop 3	Loop 4
<input type="text"/>	<input type="text"/>	<input type="text"/>	<input type="text"/>
Consumption in stand-by mode (A):			
<input type="text"/>	<input type="text"/>	<input type="text"/>	<input type="text"/>
Max. current consumption in alarm (A):			
Loop 1	Loop 2	Loop 3	Loop 4
<input type="text"/>	<input type="text"/>	<input type="text"/>	<input type="text"/>
Consumption in alarm mode (A):			
<input type="text"/>	<input type="text"/>	<input type="text"/>	<input type="text"/>

1. Insert the number of the devices connected to the loop devided for type:

Detectors	Sirens	Sound level		Modules	Accessories
		High	Low		
41RCS000	41SAI000	<input type="checkbox"/>	<input type="checkbox"/>	41IOM122 2I / 20	41ISL000 Isolators*
41RFU000	41SCI000	<input type="checkbox"/>	<input type="checkbox"/>	41IOM122 Output	48FPT000 Remot LED indicators*
41RML000	41SAB000	<input type="checkbox"/>	<input type="checkbox"/>	41IOM004 4 Output	
41PAM000				41IOM040 4 Input	
				41ISC000 Supplied by loop	
				41ISC000 Ext. Supplied	
				41IOM000 Supervised Output	
				41IOM010 Miniaturized Input	

Total number of addressable devices: Consumption, mA: **Calculate**

2. Calculation of the loop lenght correlated to the cross section of the cable:

Insert the cross section of the cable used in order to calculate the max. loop length: mm²

Case 1: The loop is open at the beginning and it is supplied only from one side. m **Calculate**

Case 2: The loop is not interrupted or it is interrupted at halfway. m **Calculate**

3. Calculation of the cable cross section correlated to the loop lenght:

Insert the max. loop length of the cable used in order to calculate the cable cross section: m

Case 1: The loop is open at the beginning and it is supplied only from one side. mm² **Calculate**

Case 2: The loop is not interrupted or it is interrupted at halfway. mm² **Calculate**

THE ATENA BATTERY CHARGER SUPPLIES A CONTINUOUS CHARGING CURRENT OF 2A AND IS CAPABLE OF CHARGING 100 AH BATTERIES TO 80%, IN COMPLIANCE WITH THE APPLICABLE STANDARD TIME LIMITS.



ASPIRATING SMOKE DETECTION SYSTEMS

WHAT ARE THEY?

Aspirating smoke detectors draw in air for analysis from the protected area through pipes with holes or capillary pipes. The pipes convey the aspirated air to a sensor, which can be positioned at a distance from the protected area, thereby allowing easier and more economic maintenance. For example, to protect a suspended ceiling, it is not necessary to provide inspection hatches as the pipe network running inside the ceiling requires no maintenance, in fact only the detection unit itself requires any maintenance, and this can be located outside the protected area in an easily accessible position, it will be enough to blow compressed air through the pipe network from the point at which it connects to the detection unit. With an aspirating system, no wiring is required in the protected area; all that is required is the installation of a simple plastic pipe. It is possible to create a completely invisible detection system, hiding the sampling pipe in the space above the suspended ceiling and using capillary pipes (small diameter pipes) with small holes to draw air from the protected area and convey it to the detection unit.

WHERE SHOULD THEY BE INSTALLED?

This type of fire detection system is ideally suited to the following situations:

- Areas where detection would otherwise be difficult, for example, in clean rooms, telephone exchanges, suspended ceilings, technical rooms, air ducts, etc..
- Aesthetically sensitive environments, such as museums, historic buildings, facilities with complex architecture etc..
- Environments where access to the system for maintenance purposes is difficult, such as cattle sheds, prisons, underground stations, etc..

WHAT REGULATIONS APPLY?

All aspirating smoke detection systems must be approved to EN54-20.

EN54-20 divides aspirating smoke detection systems into 3 classes according to their sensitivity:

- Class C - Normal sensitivity (equivalent to the sensitivity of a point detector system).
- Class B - Enhanced sensitivity (greater sensitivity than a point detector system).
- Class A - Very high sensitivity (environments with high air recirculation rate or environments requiring very early warning).
Can be used in rooms of all types.

One aspirating hole is equal to a smoke optical detector with standard sensitivity. Please refer to local regulation for dimensioning.

Product codes	ILS-1	ILS-2	IFT-P
Description	Aspirating unit 1 zone 1 channel	Aspirating unit 1 zone 2 channels	Aspirating smoke unit 1 zone 2 channels
Certification	EN54-20	EN54-20	EN54-20
Maximum number of holes per pipe - class A	3	3	12
Maximum number of holes per pipe - class B	6	6	36
Maximum number of holes per pipe - class C	18	18	36
Sensitivity	0.06% to 6.0% obs/m	0.06% to 6.0% obs/m	0.001% to 20% obs/m

APPLICATION

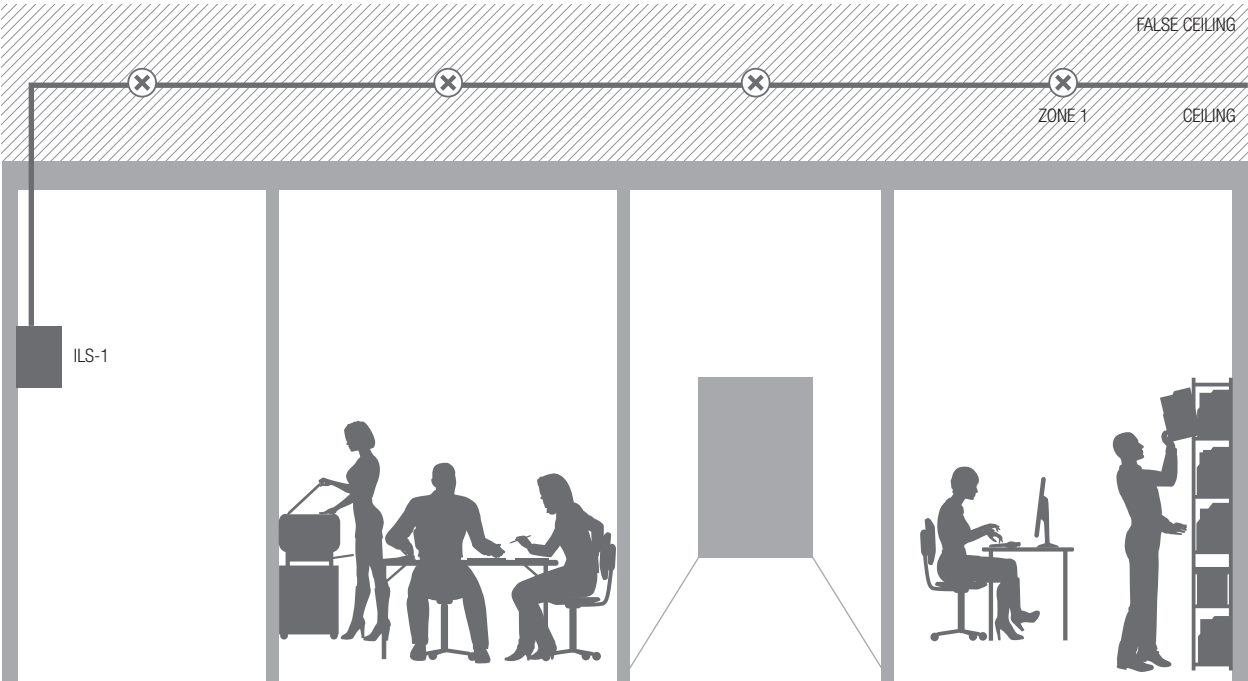

⊗ HOLES IN AIR ASPIRATING PIPE



FIRE DETECTION SOLUTIONS

GUIDE TO FIRE DETECTION

BEAM DETECTORS

WHAT ARE THEY?

A beam smoke detector is a fire detection device that uses the attenuation and/or modulation of one or more optical beams to detect smoke. Usually they consist of a powered active unit, that comprises the functions of emitter and receiver, and an unpowered passive unit, that reflects the beam of light back to the active unit. When the active unit detects a difference between the light emitted and the light received, it triggers an alarm signal. The beam detector is able to determine whether an obscuration of the beam is due to the presence of smoke (partial blocking of the beam) or a physical object (total blocking of the beam). In the latter case, the unit relays a fault signal.

WHERE SHOULD THEY BE INSTALLED?

The possibility to protect large spaces with just one linear optical detector not only obviates the need to install several point smoke detectors, along with the associated wiring and preparation work, but also enhances the aesthetics of the protected area while facilitating maintenance. Usually linear optical detectors are installed in:

- Large buildings with big open spaces, such as car parks, warehouses, dining rooms in restaurants and hotels, schools, long corridors, tennis courts and other sports facilities, hangars etc..
- Historic buildings and aesthetically sensitive environments, such as churches, museums, palaces, arenas, art galleries, luxury shops, etc..

Code	Distance from ceiling (minimum)	Coverage
48BFC002	30 cm	5-50m
48BFC003	30 cm	50-100m

APPLICATION

SMOKE DETECTOR 48BFC002

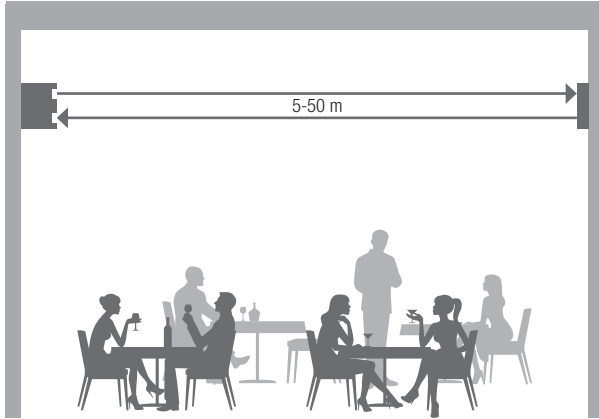

DINING ROOM - RESTAURANT

SMOKE DETECTOR 48BFC003

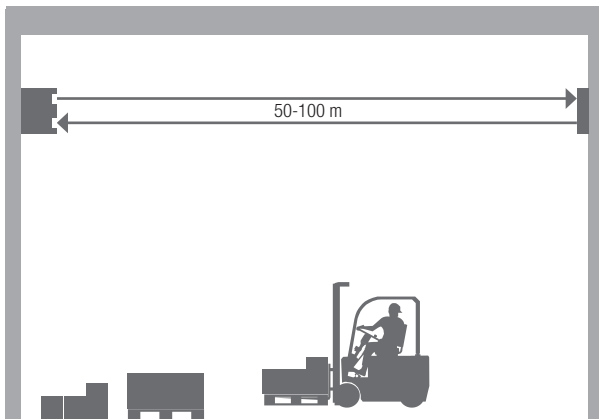

WAREHOUSE

SMOKE DETECTOR 48BFC003

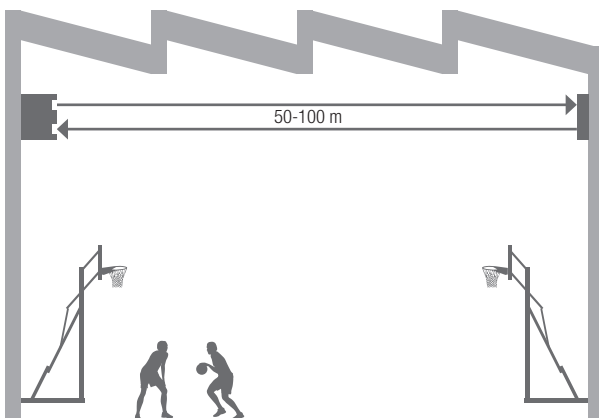

GYM WITH PITCHED OR SAW-TOOTH CEILING

* The percentage value may vary according to the maximum height of the ceiling



ATEX SYSTEMS

WHAT ARE THEY?

The word ATEX is derived from the French "**AT**mosphères **EX**plosibles" and is used in reference to zones where there is risk of explosion due to the nature of atmosphere and the elements it contains. Fire detection systems in ATEX zones must employ devices with very low operating voltages to avoid the creation of sparks that could start a fire or cause an explosion.

In these areas the rapid response of fire detectors is essential, as is the need to initiate evacuation promptly. Comelit fire detection equipment for ATEX zones ensures safety and reliability, interfacing with the control panel via a Zener barrier and module 41ISC000 on the loop. A typical layout is shown below for an installation in a chemical factory.

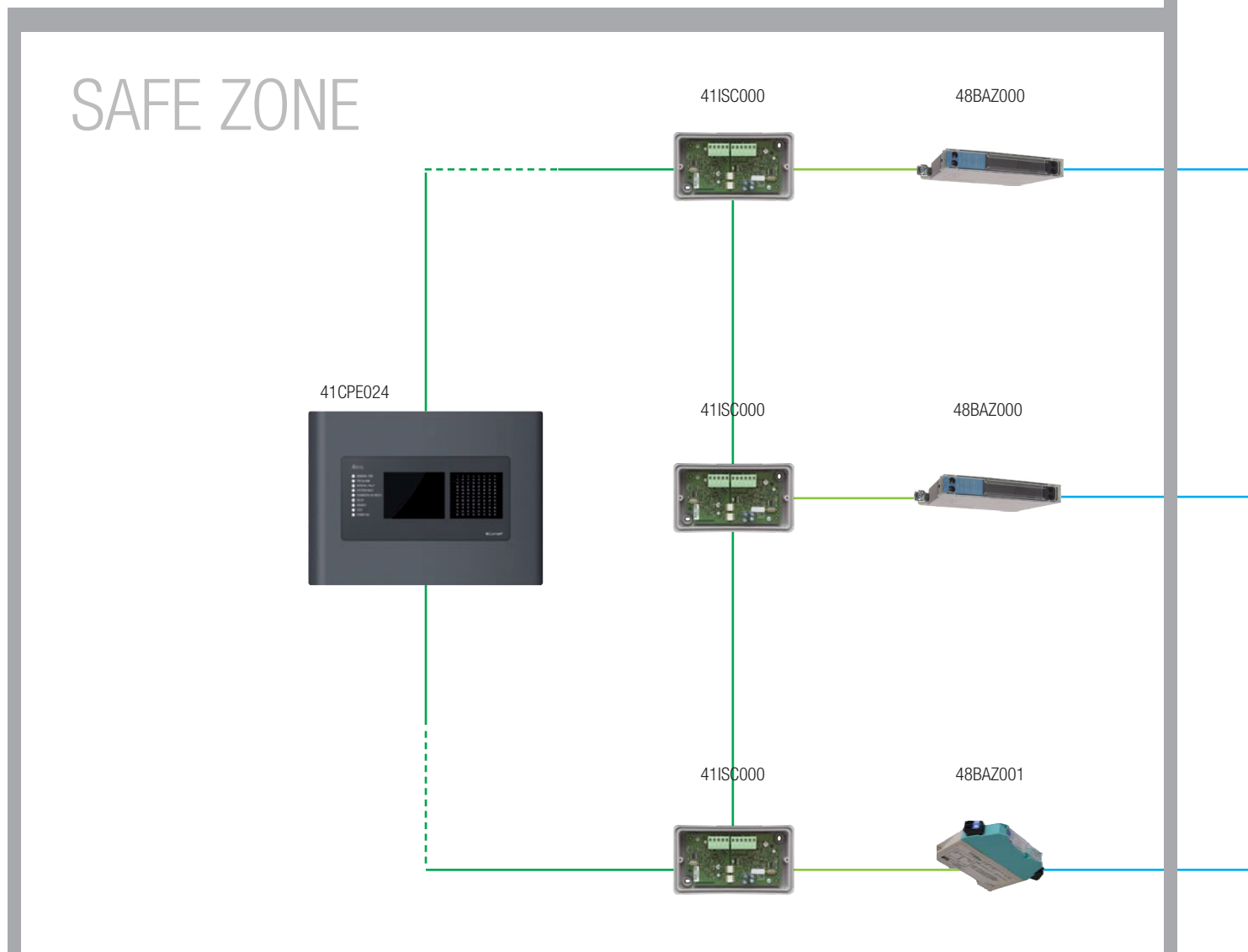

ATEX ZONE

48RCX000



48PAX000



48SAX000





FIRE DETECTION SOLUTIONS

GUIDE TO FIRE DETECTION

ATENA MANAGER SUPERVISION SOFTWARE

WHAT IS IT?

Atena manager is supervision software for installations equipped with the Atena addressable control panel (art. 41CPE024). This programme enables you to view a graphic image of the protected building and the status of the entire system, and to execute system commands when necessary. The control panel is connected to the supervision software via a LAN cable.

HOW DOES IT WORK?

The software is simple to use and effective. Once the software is installed, you can load building schematics (JPG, BMP, PNG, TIF, GIF) and then enter graphically all the devices in the system.

Atena Manager can control up to 32 Atena control panels connected in a network, with 1000 devices per control panel. It signals all alarm and fault conditions and enables the user to silence buzzers, sirens, to launch an evacuation procedure and to reset the control panel. In the event of an alarm on a floor of the building, the software will automatically display the image of the area in question in the foreground and indicate the device which generated the alarm.

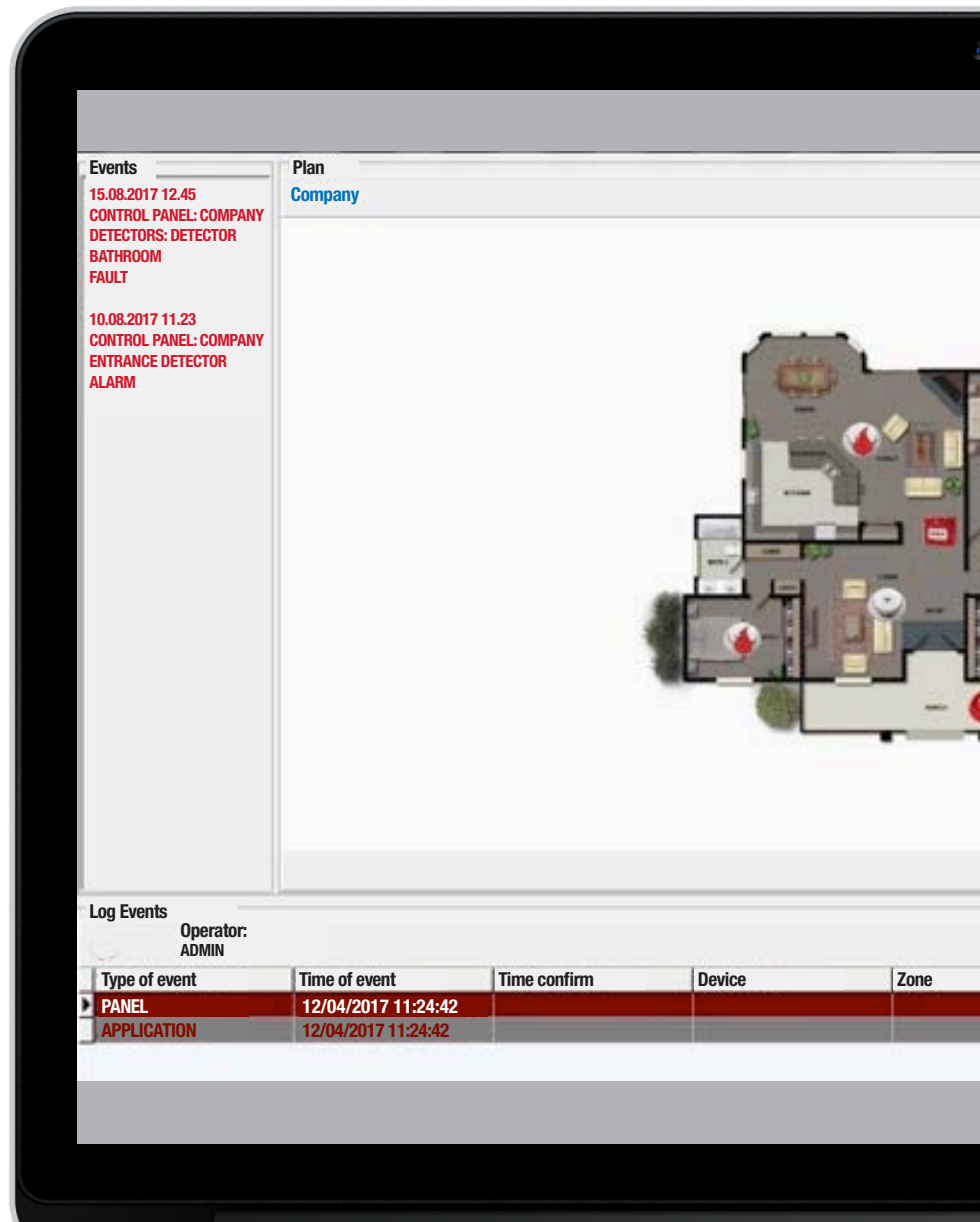

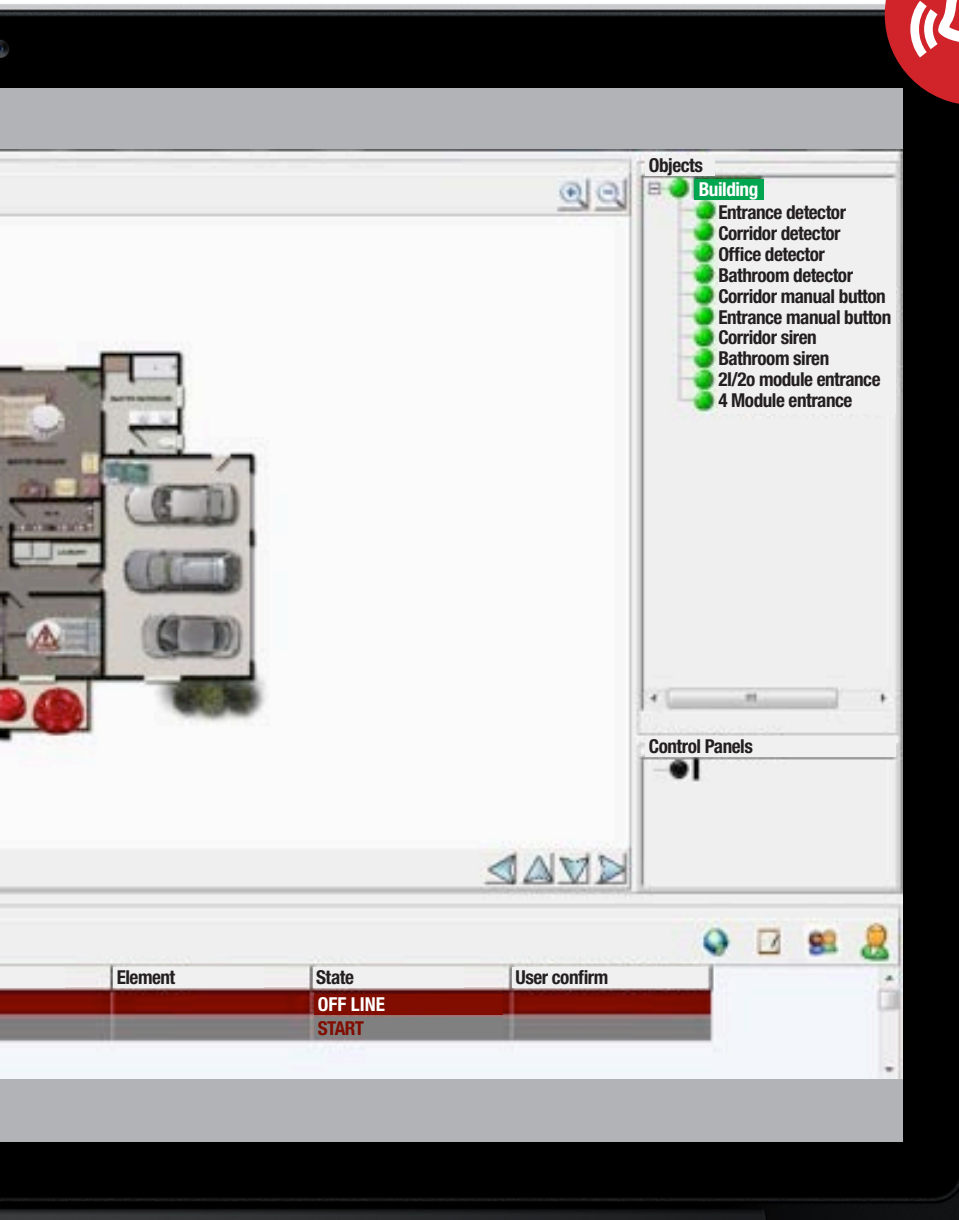



APPLICATION

GUIDE TO FIRE DETECTION

APPLICATION

SMALL COMMERCIAL FACILITY OFFICES

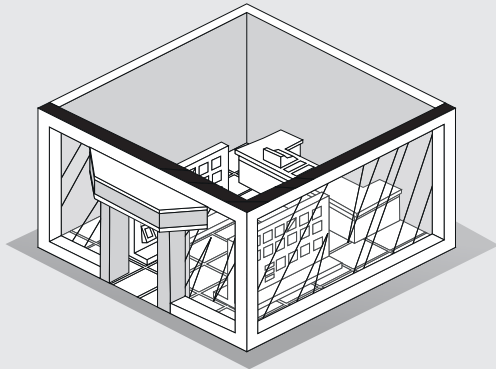

FIRE DETECTION SYSTEM

Comprised of Eracle conventional control panel for 4 zones, manual call points and smoke detectors.



Code	Description	Qty.
43CPC004EN	Eracle conventional 4-zone fire detection panel	1
43RFU000	Conventional optical smoke detector	10
43PAM000	Conventional manual call point	6
48SAI020	Indoor 32 tone siren	1
48SCI060	Sounder with white strobe	1
48SCI020	Wall-mounted siren + white strobe - IP21	1
48SCI040	Sounder with red strobe	1

FIRE DETECTION

CONVENTIONAL LINE 
 GENERIC CONNECTIONS 

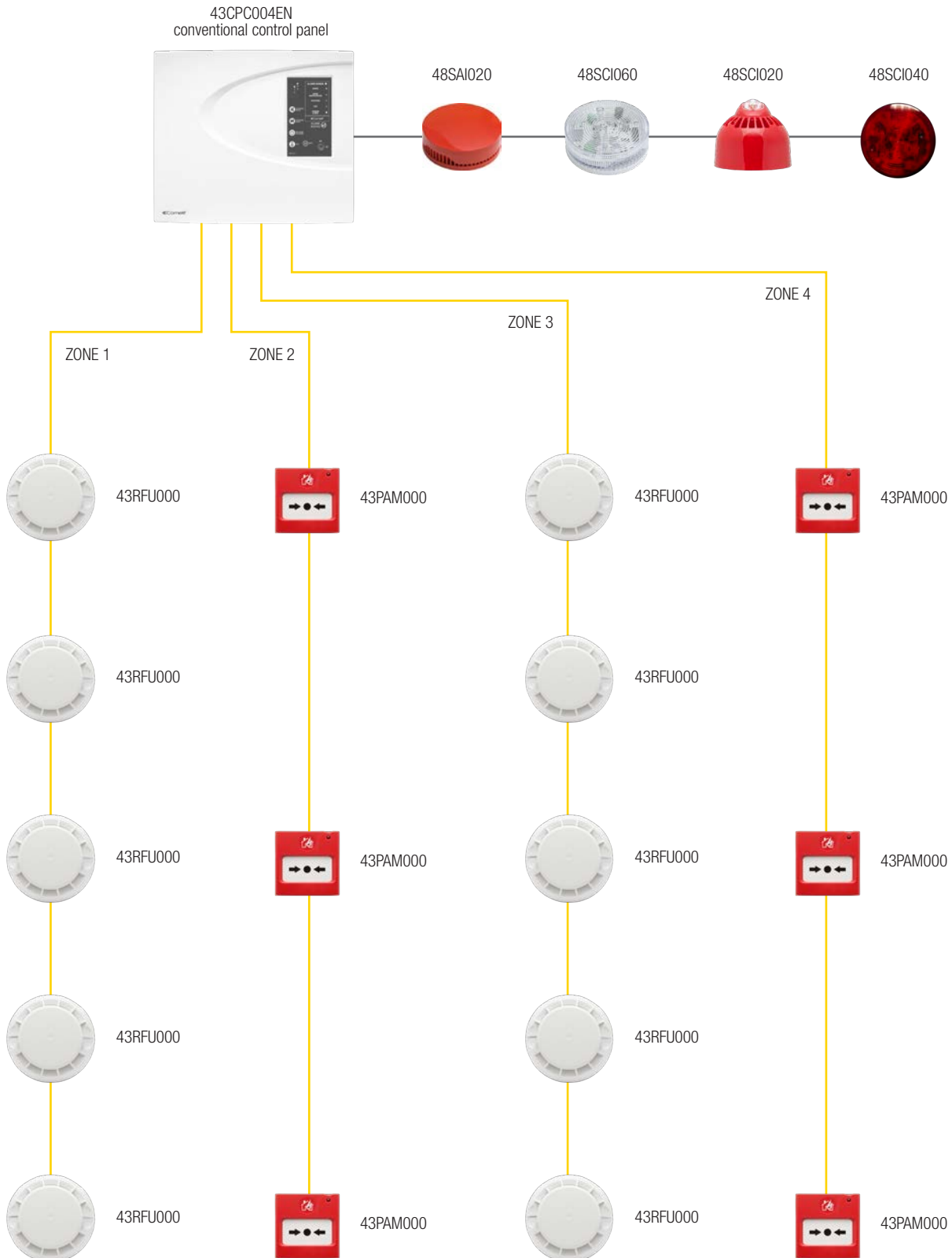



APPLICATION

GUIDE TO FIRE DETECTION

APPLICATION INDUSTRIAL

FIRE DETECTION SYSTEM

Comprised of an Atena addressable control panel, manual alarm buttons, smoke detectors and indoor siren; combined with aspiration system.

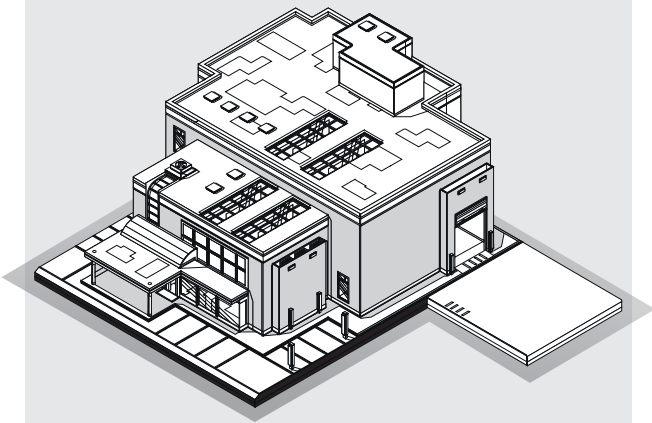

Code	Description	Qty.
41CPE024EN	Atena expandable addressable fire detection control panel	1
41ISC000	Addressable module for conventional zone	1
ILS-1	Aspirating detector, 1 zone 1 detect.	1
ILS-2	Aspirating detector, 1 zone 2 detect.	1
41IOM000	Addressable module with 1 supervised output	1
41IOM040	Addressable module with four supervised inputs	2
41RFU000	Addressable optical smoke detector	2
41SCI000	Addressable indoor siren w/ strobe for conn. in loop	2
41PAM000	Addressable manual call point	1
41BSE000	Base for addressable sirens IP65	1
48BFC002	Beam detector with reflector 5-50M	1
48ALM001	4A Additional power supply unit	1
48CMI000	6" Indoor bell - IP33C	1
48SAI020	Indoor 3-tone piezo siren 24vdc	2
48SCI040	Sounder with red strobe	1
48SCI060	Sounder with white strobe	1
48FME051	Magnetic door holder 50 Kg	1

FIRE DETECTION

- ADDRESSABLE CONTROL PANEL LOOP —
- ASPIRATION PIPES —
- GENERIC CONNECTIONS —

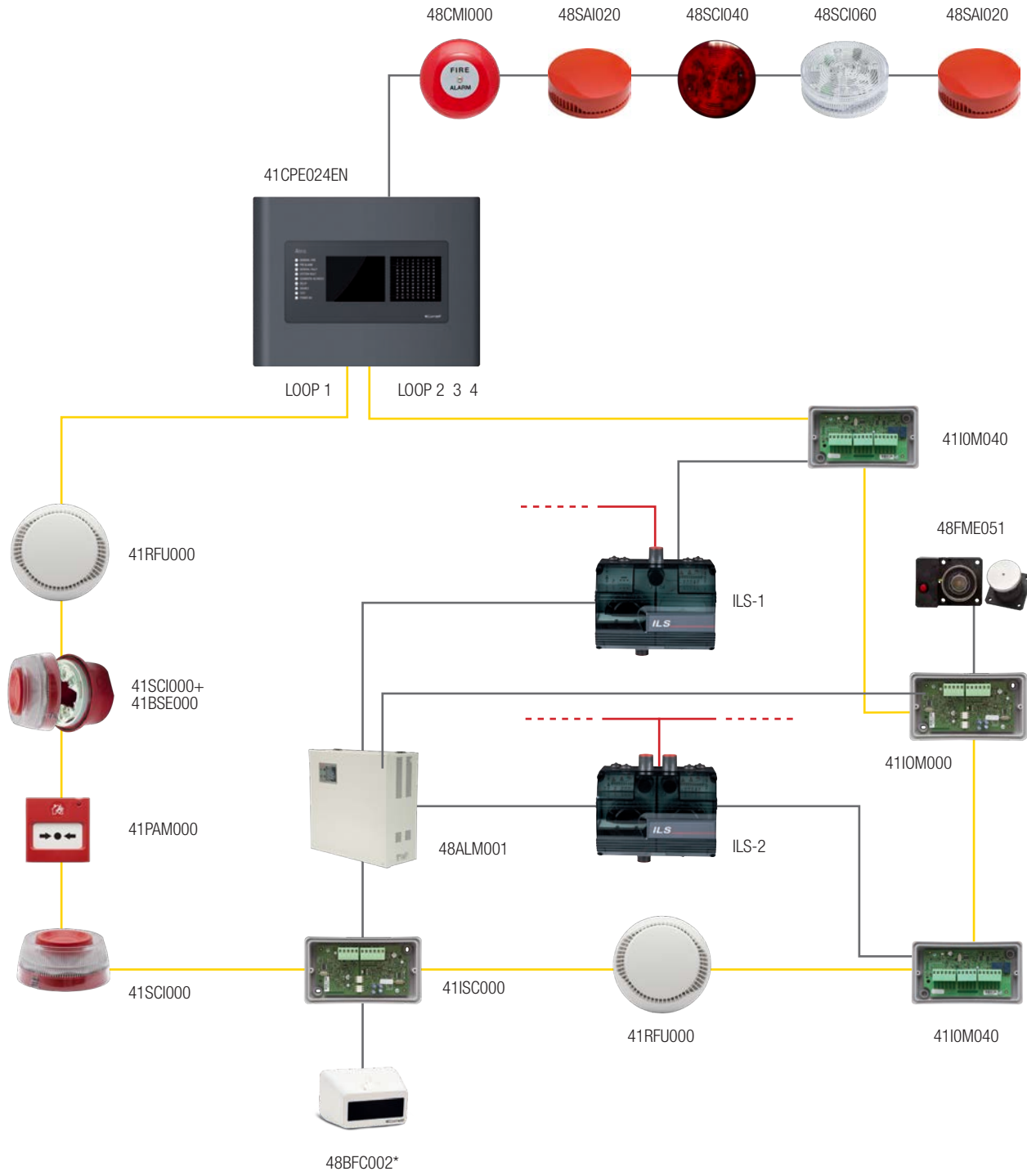

***Check the absorption of linear barriers with the current available**



APPLICATION DIAGRAMS
GUIDE TO FIRE DETECTION

CONVENTIONAL LINE (GENERAL LAYOUT)

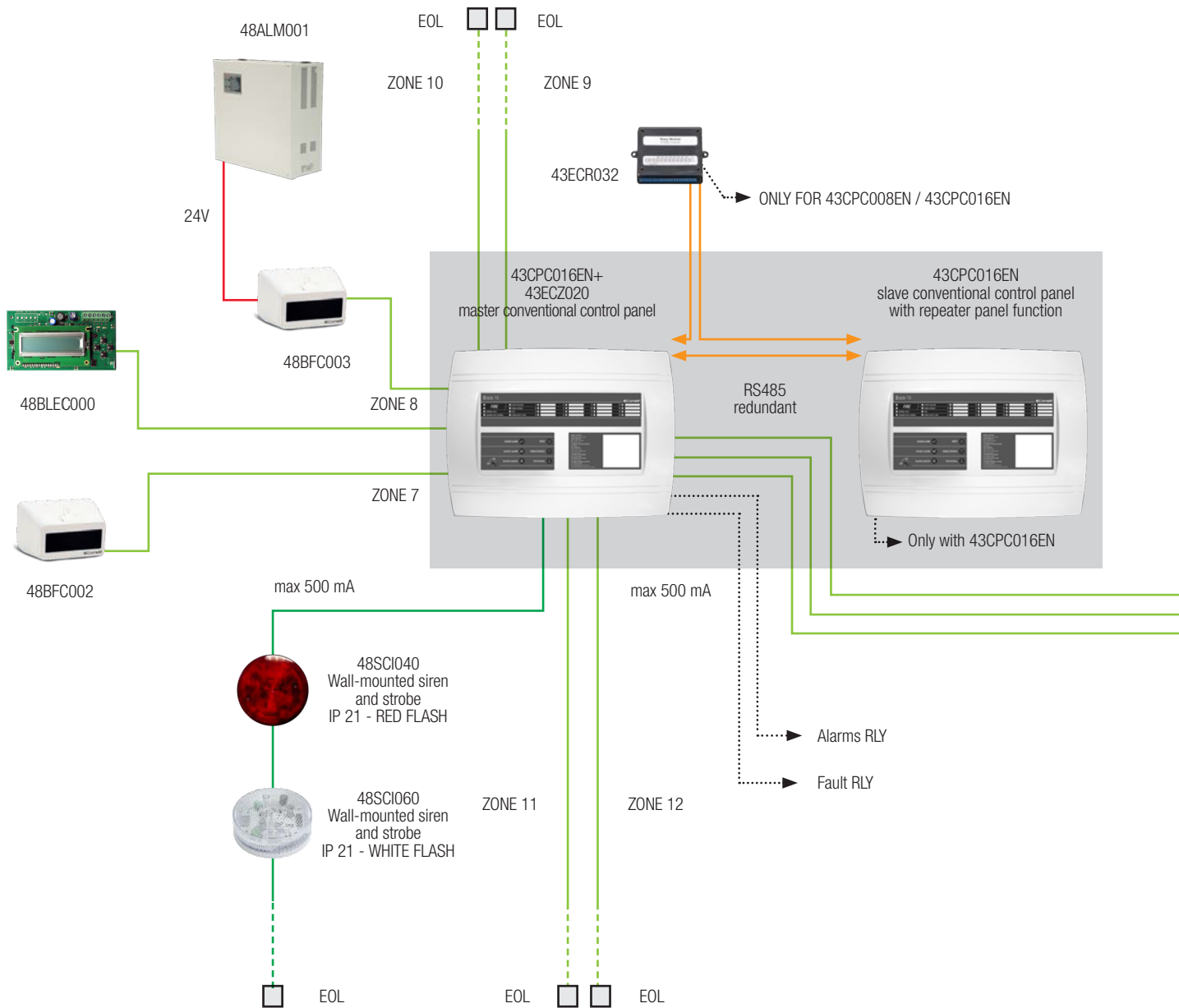

FIRE DETECTION

- ZONE —
- SUPERVISED 24v OUTPUTS —
- RS485 —
- 24V POWER SUPPLY —

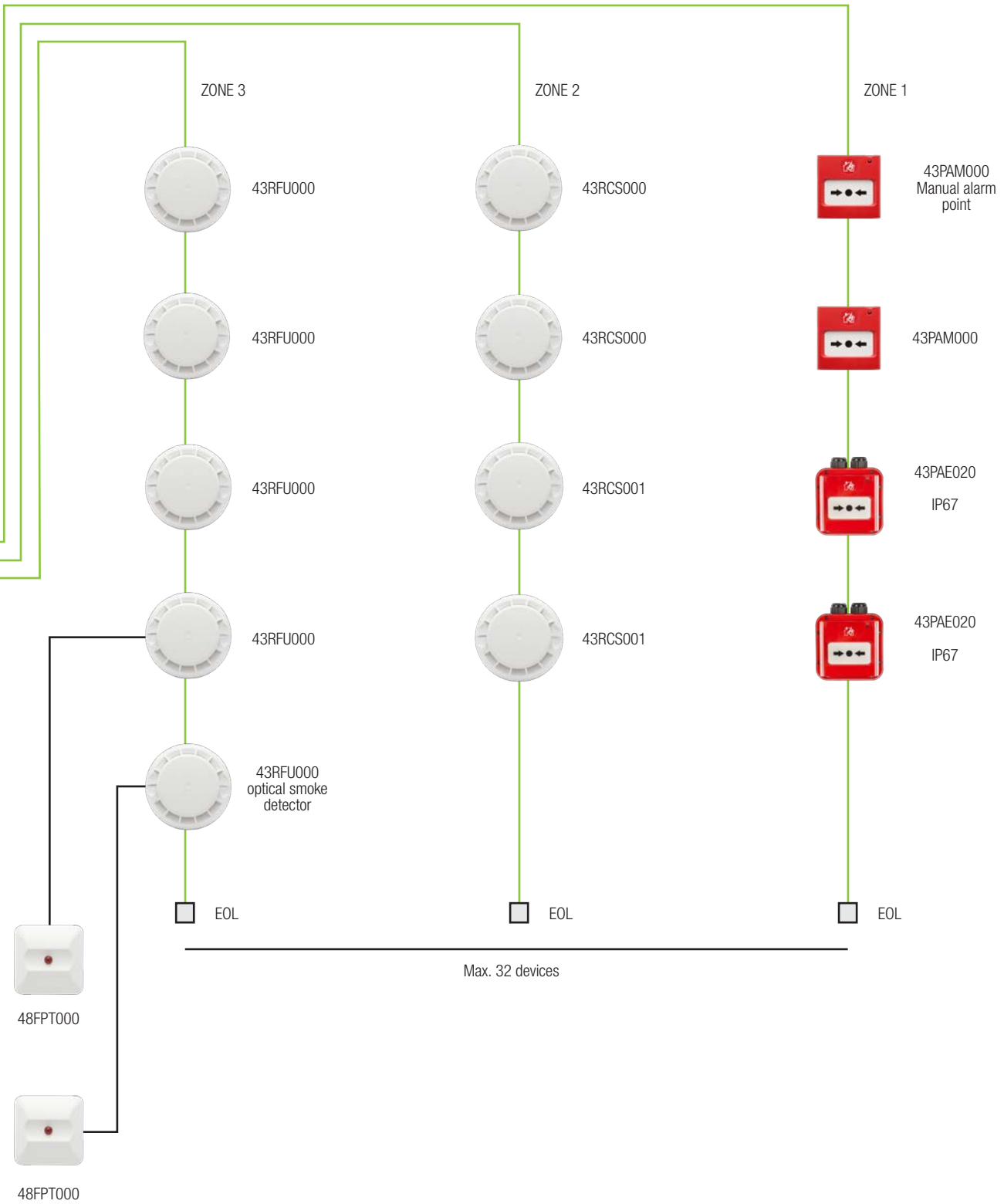



APPLICATION DIAGRAMS

GUIDE TO FIRE DETECTION

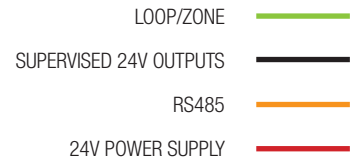

ADDRESSABLE LINE (GENERAL LAYOUT)

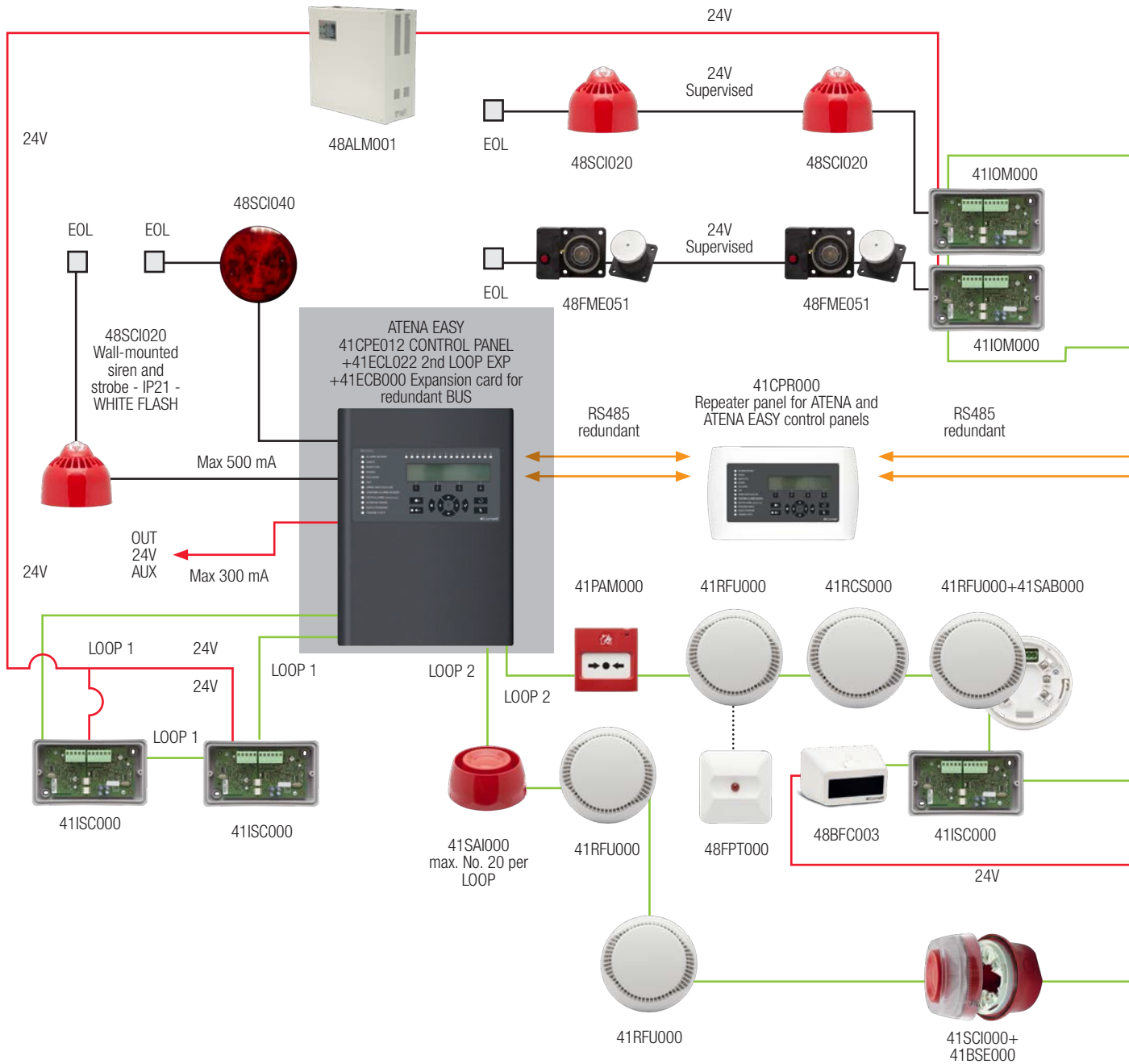

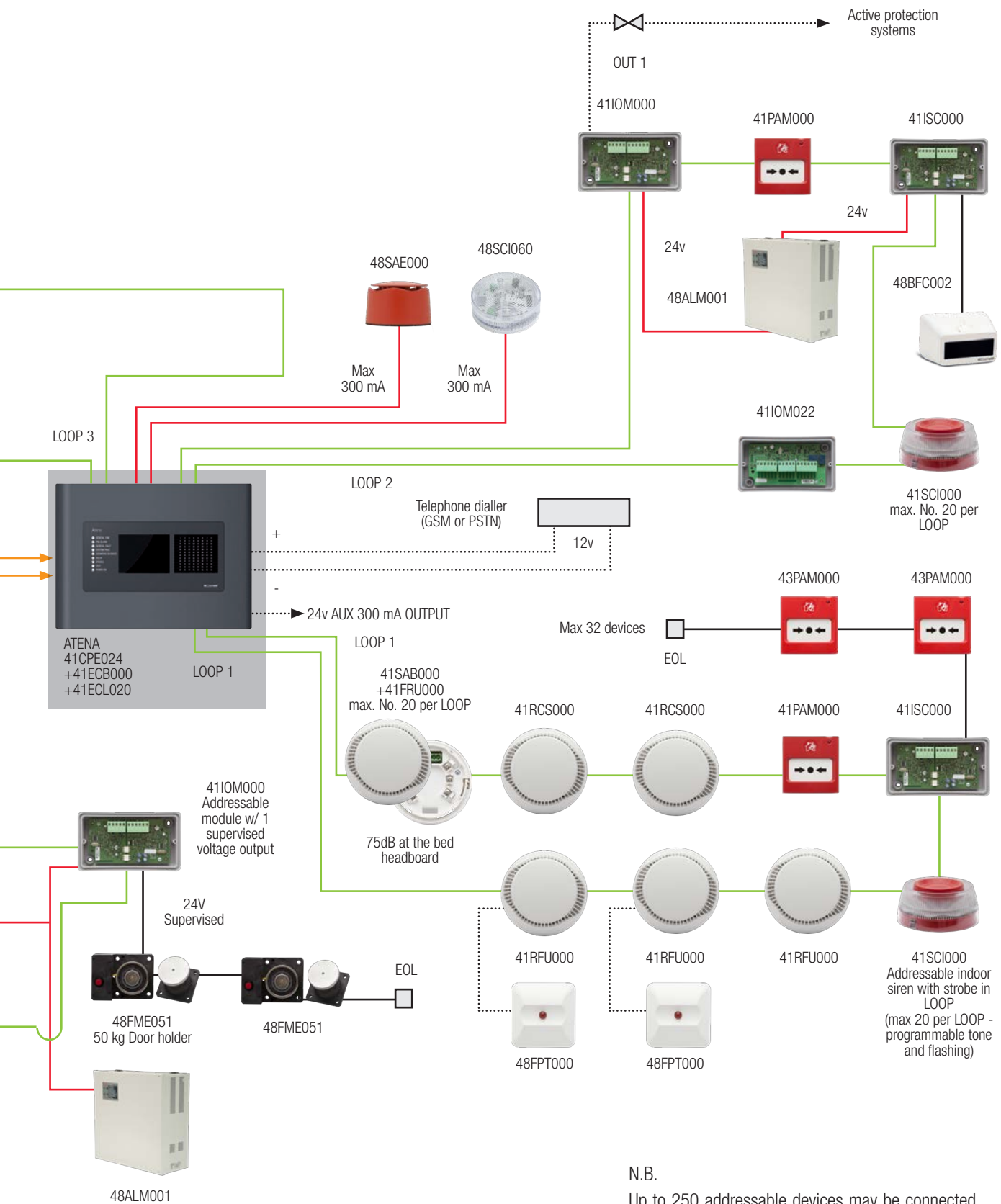

N.B.
Up to 250 addressable devices may be connected on each LOOP.
All the devices indicated can be connected in both Comelit addressable analogue control panels.



APPLICATION DIAGRAMS
GUIDE TO FIRE DETECTION

ASPIRATING SYSTEM (GENERAL LAYOUT)

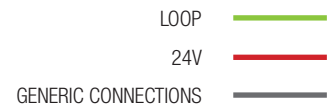

Fire detection control panel loop
41CPE012 / 41CPE024

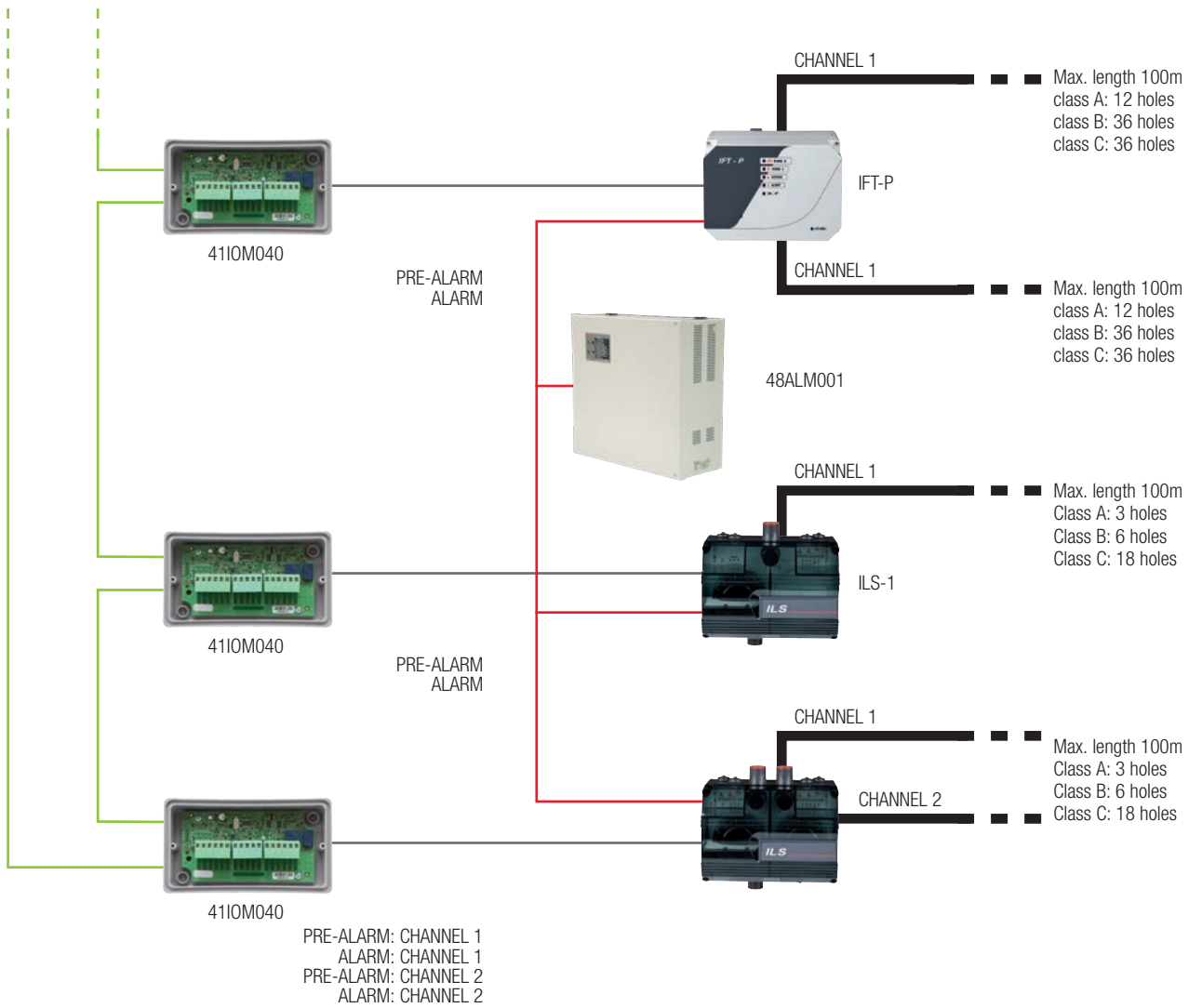

CONVENTIONAL SYSTEM

CONTROL PANELS	28
MODULES	29
CONVENTIONAL DETECTORS	30

ADDRESSABLE SYSTEM

CONTROL PANELS	32
PROGRAMMING DEVICES AND SOFTWARE	33
ADDRESSABLE DETECTORS	34
AUDIBLE AND VISUAL DEVICES	35
MODULES	36

COMMON ACCESSORIES

BEAM DETECTORS	37
VISUAL AND AUDIBLE ALARMS	38
DUCT DETECTORS	39
DOOR HOLDERS	40
ACCESSORIES	41

ASPIRATING SYSTEM

ASPIRATING UNITS	42
ASPIRATION ACCESSORIES	42

WIRELESS EXPANSION 45

ATEX SYSTEM 46

PRODUCT CATALOGUE

FIRE DETECTION









CONVENTIONAL SYSTEM

GUIDE TO FIRE DETECTION

CONVENTIONAL CONTROL PANELS

				
	ERACLE 16	ERACLE 8	ERACLE 4	ERACLE 2
PRODUCT CODE	43CPC016EN	43CPC008EN	43CPC004EN	43CPC002EN
DESCRIPTION	Eracle conventional fire detection panel with 8 to 16 zones	Eracle conventional 8-zone fire detection panel	Eracle conventional 4-zone fire detection panel	Eracle conventional 2-zone fire detection panel
SOFTWARE/FIRMWARE SPECIFICATIONS				
Number of Events log	510 (with art. 43LEC000)			
FUNCTIONS				
MANAGEMENT BY PANEL REPEATER	YES			
NUMBER OF RELAY (WITH EXPANSION)	8 (with art. 43ECR032)	8 (with art. 43ECR032)		
SIREN ACTIVATION DELAY	1÷10 minutes	1÷10 minutes		
DETECTION WITH CONFIRMATION (DOUBLE KNOCK)	YES			
INSTANT ZONE	Programmable	Programmable		
NUMBER OF 4 ZONES EXPANDER	2 (2 x art. 43ECZ020 max)			
NUMBER OF 4 SIRENS EXPANDER	1 (with art. 43ECS020)			
HARDWARE CHARACTERISTICS				
IP PROTECTION GRADE	IP30			
NUMBER OF DETECTION ZONES AVAILABLE	8 expandable up to 16	8	4	2
COMELIT SENSORS AND ALARM BUTTONS PER ZONE (MAX)	32			
MONITORED OUTPUT	4 (0.3A max each)	2 (0.3A max each)		
NUMBER OF FIRE RELAY	1 (1A@12 VDC, 0.5A@24 VDC)	1 (3A@24 VDC)	1 (3A@120 VAC, 3A@60 VDC)	
NUMBER OF FAULT RELAY	1 (1A@12 VDC, 0.5A@24 VDC)	1 (3A@24 VDC)	1 (3A@120 VAC, 3A@60 VDC)	
GENERAL DATA				
ENCLOSURE	Plastic			
DIMENSIONS (H x W x D)	441x331x80mm	340x290x100mm		
WEIGHT (WITHOUT BATTERY)	4 Kg	2.4 Kg	2.1 Kg	
PROTECTION LEV. 2	Mechanical key			
NOTIFICATIONS	LED			
MAX CROSS SECTION OF CONNECTION CABLES	2.5 mm ²			
CERTIFICATION STANDARD	EN54-2, EN54-4			
TECHNICAL CHARACTERISTICS				
OPERATING TEMPERATURE	-5°C to 40°C			
STORAGE TEMPERATURE	-20°C to 60°C			
OPERATING RELATIVE HUMIDITY	(93 ± 3)% @ 40°C			
ELECTRICAL SPECIFICATIONS				
BACKUP POWER SUPPLY (SEALED LEAD BATTERIES)	1x 12V, 18Ah, 4.5A fuse	1x 12VDC, 7Ah, 4.5A fuse	1x 12Vcc, 7Ah, fusibile 2A	1x 12VDC, 7Ah, 2A fuse
POWER SUPPLY FOR EXTERNAL DEVICES	24 (0.3A max)			
MAIN POWER SUPPLY	230 VAC ± 10% (fuse 2A)	230 VAC ± 10% (fuse 0,3A)		
ZONE ALARM THRESHOLDS (mA)	10 to 110			
NETWORK POWER CONSUMPTION (mA)	50			
MAX. POWER CONSUMPTION OF CONNECTED DEVICES WITH CHARGED BATTERY (A)	0.7			
OUTPUTS CIRCUIT FOR SIRENS	24VDC/0.15A, fuse (PTC)	24VDC/0.5A, 0.5A fuse (PTC)	24VDC/0.3A, 0.3A fuse	
ZONE POWER SUPPLY AND SHORT CIRCUIT THRESHOLDS (mA)	>110			
ZONE FAULT OR OPEN CIRCUIT THRESHOLDS (mA)	0-2			
ZONE POWER SUPPLY VOLTAGE AND NORMAL MODE THRESHOLDS (mA)	2 to 10			
FAULT RELAY/ALARM RELAY OUTPUTS (SPDT WITH VOLT-FREE CONTACTS)	3A@120 VAC, 3A@60 VDC			

CONVENTIONAL CONTROL PANEL MODULES



43ECR032 **8 RELAY EXPANSION MODULE FOR ERACLE 8 AND ERACLE 16**
 The 8 relay expansion module can be connected to the ERACLE 8 or ERACLE 16 control panel 43CPC008 via serial port. Each relay is associated with a zone and will be activated in the event of a fire alarm being generated in that zone. Any siren activation delay set on the control panel will also be applied to the relays of module 43ECR032. Power supply voltage: 24Vdc. Current consumption on standby: 8 mA Additional consumption for each active relay: 10 mA. Maximum current consumption: 2 A. Contacts capacity: 1A - 12V or 0.5A - 24V. Cable cross section: 1.5 / 2.5 mm². Operating temperature -5°C / +40 C. Operating relative humidity: (93 ± 3) % - 40 °C. Dimensions:(HxLxD): 130x111x41 mm. Weight: 0.4 kg



43ECZ020 **MODULE 4 ZONES FOR ERACLE 16**
 4 zones expander module for ERACLE 16. It is possible to connect up to 32 devices to each zone. Consumption in stand-by mode 130mA. Consumption in alarm 330mA. Dimensions 57x81mm. Weight 200g.



43ECS020 **MODULE 4 SIREN OUTPUTS FOR ERACLE 16**
 4 sounder lines expander module for ERACLE 16. Consumption in alarm 150mA. Operating temperature 0°C to +40°C. Weight 200g. Dimensions 57x81mm



43LEC000 **LOG EVENT FOR ERACLE 8 AND ERACLE 16**
 Log Event for ERACLE 8 and ERACLE 16. Number of memory event 510. Nominal voltage 24Vdc. Consumption in stand-by mode 25mA. Consumption with activated backlight: 55mA±2mA. Maximum consumption with activated backlight and relay output: 76mA±2mA. Dimensions: 125x66mm



43CRE000 **SET OF 5 PAIRS OF KEYS FOR ERACLE CONTROL PANEL**
 Set of 5 pairs of keys for Eracle control panel.





43EOL000 **SET OF 5 END-OF-LINE RES. FOR CONVENTIONAL ZONE**
 Set of 5 end-of-line resistors for conventional zone.



CONVENTIONAL SYSTEM

GUIDE TO FIRE DETECTION

CONVENTIONAL DETECTORS

				
PRODUCT CODE	43RCS000	43RCS001	43RFU000	43RML000
DESCRIPTION	Rate-of-rise heat detector with fixed threshold of 58°	Heat detector with fixed threshold of 60°	Optical smoke detector	Multicriteria smoke/heat detector
FUNCTIONS				
SELF DIAGNOSIS	YES			
LED INDICATIONS	2, 360° visibility			
PROTECTED AREA DIMENSIONS (m ²)	35 (max 3.5m high)			120 (max 16m high)
HARDWARE SPECIFICATIONS				
IP RATING	IP30			
GENERAL DATA				
DETECTOR CLASS (IN ACCORDANCE WITH A EN54-5)	A1/R	A2/S		A1/R
COLOUR	White			
DIMENSIONS (ØXH - mm - BASE INCLUDED)	102mm, h 42mm			102mm, h 48mm
WEIGHT (g)	160g			170g
CABLE CROSS SECTION (mm ²)	2mm ²			
CERTIFICATION STANDARD	EN54-5		EN54-7	EN54-5, EN54-7
TYPE OF DETECTION POINT	Rate-of rise heat detector with fixed threshold of 58°C	Heat detector with fixed threshold of 60°C	Optical smoke detector	Multicriteria smoke/heat detector
TECHNICAL CHARACTERISTICS				
OPERATING TEMPERATURE (°C)	-10°C ÷ 60°C			
SETTLING TIME ON POWER UP	30s			
OPERATING RELATIVE HUMIDITY (%)	(93 ± 3)% @ 40°C			
ELECTRICAL SPECIFICATIONS				
CONSUMPTION IN ALARM WITH BASES 43RBX000 AND 43RBX001	20mA @ 12VDC			20mA, 12÷30V
CURRENT CONSUMPTION IN ALARM STATE WITH BASE TYPE 43RBX003	18mA @ 9VDC, 29mA @ 12VDC, 32mA @ 15VDC			
AVERAGE CURRENT CONSUMPTION IN INACTIVE STATE	<50uA			
OPERATING VOLTAGE	9÷30 (12÷24 nominal)			
OUTPUT IN ALARM STATE FOR REMOTE INDICATION	20mA@3.3VDC			



43RBX000

BASE FOR CONVENTIONAL SENSORS

The standard base for conventional detectors has a low-profile design and an extremely reliable sensor connection system that provides a secure fixing for the detector. Dimensions: ø 102 mm, h 11 mm.



43RBX001

BASE WITH DIODE FOR CONVENTIONAL SENSORS

The standard base with diode for conventional detectors has a low-profile design and an extremely reliable sensor connection system that provides a secure fixing for the detector. The diode senses when the detector is removed from its base. Dimensions: ø 102 mm, h 11 mm. Weight: 42 g.



43RBX003

BASE WITH RELAY FOR CONVENTIONAL SENSORS

The base with relay for conventional detectors has a low-profile design and an extremely reliable sensor connection system that provides a secure fixing for the detector. The base is equipped with a 12Vdc relay for interfacing with security systems. It can also operate in reset mode. Dimensions: ø 102 mm, h 11 mm. Weight: 46 g.



43RBA002

SPACER FOR CONVENTIONAL SENSORS

The spacer enables mounting of sensors on uneven surfaces, suspended ceilings, etc..



43PAK000

SPARE KEY FOR MANUAL CALL POINT

Spare key for 41PAM000, 43PAM000, 43PAE020 and 41PAE020.



48FPT000

REMOTE LED INDICATOR

Remote indicator that repeats status of detectors. Compatible with sensors and bases that support this function. Current consumption in active state: 30 mA; Cable cross-section: 0.4 - 2.5 mm². Operating temperature -10°C / +60°C. Operating relative humidity: (93 ± 3) % - 40 °C. Dimensions: 85x85x20 mm. Weight: 42 g.



43PAE020

CONVENTIONAL MANUAL CALL POINT IP67

Manual alarm point IP67 designed to be used in conventional detection systems. The manual call point is equipped with a resettable plastic key element (supplied) and sends an alarm signal to the control panel when it is activated by pressing the indicated point. It is equipped with frontal LED for signaling the alarm or test status. Resettable flexible element with special recovery key supplied. Wall mounting. Red ABS container. Certification according to EN54-11.

Note: the declared IP67 is achieved only when using IP67 rated cable glands



43PAM000

CONVENTIONAL MANUAL CALL POINT

Manual alarm point designed to be used in conventional detection systems. The manual call point is equipped with a resettable plastic element (supplied) and sends an alarm signal to the control panel when it is activated by pressing the indicated point. It is equipped with frontal LED for signaling the alarm or test status. Resettable flexible element with special recovery key supplied. Wall mounting. Red ABS enclosure. Certification according to EN54-11.



43PAT000

PROTECTIVE BUTTON COVER, SET OF 5 PCS



Set consisting of 5 protective covers in transparent plastic material, for button models 41PAM000, 43PAM000, 43PAE020 and 41PAE020.



ADDRESSABLE SYSTEM

GUIDE TO FIRE DETECTION

ADDRESSABLE CONTROL PANELS

	 ATENA EASY	 ATENA
PRODUCT CODE	41CPE012	41CPE024EN
DESCRIPTION	Atena Easy expandable addressable fire detection panel	Atena expandable addressable fire detection control panel
SOFTWARE/FIRMWARE SPECIFICATIONS		
NUMBER OF EVENTS LOG	10.000	
OPERATING MODE WITH/WITHOUT SUPERVISION (DAY/NIGHT)	YES	
NUMBER OF CONTROL PANELS THAT CAN BE CONNECTED VIA ETHERNET	32 with integrated TCP/IP interface	
PROGRAMMING VIA PC	With Atena Prog software (MicroLab)	
LOCAL PROGRAMMING	Via menu on display and keypad	Via menu on touch screen display
FUNCTIONS		
PROGRAMMABLE LOGIC FUNCTIONS	Up to 256 with AND/OR inputs and outputs	
DEVICE ADDRESSING WITH AUTO-ACQUISITION OF LOOP DEVICES	YES	
SENSOR ADDRESSING WITH ELECTRONIC PROGRAMMER 41SPG000	YES	
SIREN ACTIVATION DELAY	1÷10 minutes	
DETECTION WITH CONFIRMATION (DOUBLE KNOCK)	YES	
CONNECTIVITY	RS485	RS485 / LAN
HARDWARE SPECIFICATIONS		
IP PROTECTION GRADE	IP30	
DEDICATED INPUTS FOR INTERFACING WITH EXTINGUISHING SYSTEMS	3	
ZONE STATUS INDICATOR LEDs	16	96
NUMBER OF LOOPS	1 fitted, expandable to 2 with card 41ECL022	1 fitted, expandable to 4 with 1 loop expansion card 41ECL020
NUMBER OF DETECTION ZONES AVAILABLE	48	96
MAX. NUMBER OF CONTROL PANELS ON REDUNDANT RS485 NETWORK	32	
MAX. NUMBER OF DEVICES PER LOOP	250	
NUMBER OF FIRE RELAY	1 (0,3A@24 VDC)	2 (0,3A@ 24VDC)
NUMBER OF FAULT RELAY	1 (0,3A@24 VDC)	1 (0,3A@ 24VDC)
GENERAL DATA		
ENCLOSURE	Metallic	
DIMENSIONS (H X W X D)	306x412x81mm	430x415x120mm
DISPLAY	Alphanumeric LCD with 4 rows by 40 characters	Graphic LCD touch screen, 320x240pixel
WEIGHT (WITHOUT BATTERY) (G)	4200	6000
CERTIFICATION STANDARD	EN54-2, EN54-4	EN54-2, EN54-4, LPCB
TECHNICAL CHARACTERISTICS		
ACTIVATION DELAY MANAGEMENT	1, on alarm outputs	
OPERATING TEMPERATURE (°C)	-10°C ÷ 50°C	
OPERATING RELATIVE HUMIDITY	(93 ± 3)% @ 40°C	
ELECTRICAL SPECIFICATIONS		
BACKUP POWER SUPPLY (SEALED LEAD BATTERIES)	1x 12VDC, 18Ah, 4.5A fuse	
POWER SUPPLY FOR EXTERNAL DEVICES (VDC)	1 x 24	1x12, 1x24
MAIN POWER SUPPLY	230 VAC ± 10% (fuse 0,3A)	
NETWORK POWER CONSUMPTION (MA)	65	95
POWER SUPPLY VOLTAGE A	90÷260VAC, 47÷440Hz	230VAC (+/-10%), 50Hz
OUTPUT POWER AUXILIARY DEVICES	1 (24VDC/0.5A)	1 (24VDC/0.3A)
PROGRAMMABLE RELAY OUTPUTS WITH FREE CONTACT (NO/NC)	4 (15A@24 VDC)	
OUTPUTS FOR EXTINGUISHING SYSTEM CONTROL	1 (24VDC/0.3A)	
SUPERVISED OUTPUTS FOR SIRENS	2 (24VDC/0.5A)	1 (24VDC/0.3A)

ADDRESSABLE SYSTEM



41ECL022

1 LOOP EXPANSION CARD FOR ATENA EASY ADDRESSABLE CONTROL PANEL

Maximum number of devices that can be connected: 250. Maximum current consumption: 500mA. Cable cross section: 0.4 - 2.0 mm². Operating temperature -10°C / +65 C. Operating relative humidity: (93 ± 3)% @ 40 °C. Dimensions: 65x80 mm. Weight: 30 g.



41ECL020

1 LOOP EXPANSION CARD FOR ATENA ADDRESSABLE CONTROL PANEL

Maximum number of devices that can be connected: 250. Maximum current consumption: 500mA. Cable cross section: 0.4 - 2.0 mm². Operating temperature -10 °C /+65 C. Operating relative humidity: (93 ± 3)% @ 40 °C. Dimensions: 75x80mm. Weight: 30 g.



41ECB000

NETWORK CARD FOR ATENA + ATENA EASY CONTROL PANELS

This card can be used to create a redundant serial communication network between multiple ATENA, ATENA EASY control panels and repeater panels (up to a maximum of 32), thereby ensuring a backup line of connection in the event of a fault in the physical communication link. Maximum current consumption: 500mA. Direct type: redundant serial line. Maximum number of panels in network: 32. Maximum distance between two cards: 1000 m. Recommended connection cable: twisted pair 0.5 to 2.5mm².



41CPR000

REPEATER PANEL FOR ATENA AND ATENA EASY CONTROL PANELS

The repeater panel can receive all the signals from the system and execute all the commands, even in a location far away from the control panel that cannot be easily accessed by the usual operators. Alphanumeric LCD display with 4 lines x 40 characters. General signalling of Fire alarm, Fault, CPU fault, Delayed alarm, Exclusions, Tests, Network presence, Silenced alarm. Direct commands for Silence buzzer, Silence siren, Reset, Evacuation, Signalling test. 4 menu navigation keys, ENTER key, CANCEL key. number keys 1,2,3, 4 for access code programming

PROGRAMMING DEVICES AND SOFTWARE



41SPG000

PROGRAMMING DEVICE FOR ADDRESSABLE DEVICES

The programmer 41SPG000 is the instrument used to assign addresses to all the devices connected in the loop (detectors, modules, manual call points and audible/visual alarms). It can read and write the addresses and to set the parameters of the detectors and modules. It is supplied with a 230 Vac, 50Hz/ 1.5-12 Vdc, 500mA, 6VA (max) power supply unit and 2 cables for connection of the modules and manual call points. IT can also be powered by 4 x 1.5V AA batteries. The detectors and audible and visual alarm devices can be directly connected to the base on the upper part of the programmer. Dimensions: 255x102x65 mm. Weight: 260 g.



41SWS000

ATENA MANAGER SUPERVISION SOFTWARE

ATENA MANAGER is an application for PC for the supervision of systems with ATENA and ATENA EASY control panels. ATENA MANAGER constantly monitors the status of the devices in the field and displays the data in the most common graph formats. In the event of fault or alarm conditions, these are displayed graphically on the screen accompanied by the relative audible signals. ATENA MANAGER enables system configurations to be imported directly from the database created with the software ATENA PROG. It can launch commands to silence buzzers, silence sirens, initiate evacuation and reset the control panel.

GUIDE TO FIRE DETECTION



PRODUCT CATALOGUE



ADDRESSABLE SYSTEM

GUIDE TO FIRE DETECTION

ADDRESSABLE DETECTORS

			
PRODUCT CODE	41RCS000	41RFU000	41RML000
DESCRIPTION	Addressable heat detector with isolator	Addressable optical smoke detector with isolator	Addressable multi-criteria smoke/heat detector with isolator
SOFTWARE/FIRMWARE SPECIFICATIONS			
SENSITIVITY LEVEL SETTINGS	A1R/A2R/BS	High/Normal*/Medium/Low (optical)	High/Normal*/Medium/Low (optical) - A1R (thermal)
LED INDICATIONS	2		
HARDWARE SPECIFICATIONS			
IP RATING	IP30		
GENERAL DATA			
DETECTOR CLASS (IN ACCORDANCE WITH A EN54-5)	A1/R, A2/S, B/S		A1/R
COLOUR	White		
DIMENSIONS (ØXH - MM - BASE INCLUDED)	103mm, h 42mm		103mm, h 49mm
WEIGHT (g)	110g	125g	
CABLE CROSS SECTION	2mm ²		
ISOLATOR	Yes		
CERTIFICATION STANDARD	EN54-5, EN54-17	EN54-7, EN54-17	EN54-5, EN54-7, EN54-17
TYPE OF DETECTION POINT	Rate-of rise heat detector	Optical smoke detector	Multi-criteria smoke/heat detector
TECHNICAL CHARACTERISTICS			
OPERATING TEMPERATURE (°C)	-10°C ÷ 60°C		
SETTLING TIME ON POWER UP	30s		
OPERATING RELATIVE HUMIDITY	(93±3)% @40°C		
ELECTRICAL SPECIFICATIONS			
RATED CURRENT CONSUMPTION (STAND-BY)	<170uA (27Vdc)	<190uA (27Vdc)	
CURRENT CONSUMPTION IN ALARM STATE	6.5mA		
CURRENT CONSUMPTION IN COMMUNICATION	<290uA 27Vdc	<310uA (27Vdc)	
OPERATING VOLTAGE (VDC)	15 to 32 Vdc (27 Vdc nominal)		
OUTPUT IN ALARM STATE FOR REMOTE INDICATION	7.5mA@7.5VDC		



41RBX020

BASE FOR ADDRESSABLE SENSORS

The standard base for addressable detectors has a low-profile design and an extremely reliable sensor connection system that provides a secure fixing for the detector. Maximum cable cross-section: 3.0 mm². Operating temperature -10 °C / +60 C. Operating relative humidity: (93 ± 3)% @ 40 °C. Dimensions: 103x14.7 mm. Weight: 15 g.



43PAK000

SPARE KEY FOR MANUAL CALL POINT

Spare key for 41PAM000, 43PAM000, 43PAE020 and 41PAE020.



48FPT000

REMOTE LED INDICATOR

Remote indicator that repeats status of detectors. Compatible with sensors and bases that support this function. Current consumption in active state: 30 mA; Cable cross-section: 0.4 - 2.5 mm². Operating temperature -10°C / +60 C. Operating relative humidity: (93 ± 3) % - 40 °C. Dimensions: 85x85x20 mm. Weight: 42 g.



41PAM000

ADDRESSABLE MANUAL CALL POINT

Addressable manual alarm point with integral on-board isolator. The button is equipped with an actuator that is resettable using a special plastic key (supplied) and sends an alarm signal to the control panel when it is activated in the point signalled. It is equipped with a LED for indicating alarm status or test status. Wall mounted. Red ABS enclosure. Certified to 54-11 and EN 54-17.



41PAE020

ADDRESSABLE MANUAL CALL POINT IP67

Waterproof addressable manual call point designed for outdoor installations and IP67 environments with built-in isolator module. The call point is equipped also with a protective transparent cover for avoiding of fault or accidental activation.





43PAT000

PROTECTIVE BUTTON COVER, SET OF 5 PCS

Set consisting of 5 protective covers in transparent plastic material, for button models 41PAM000, 43PAM000, 43PAE020 and 41PAE020.

ADDRESSABLE SYSTEM

AUDIBLE AND VISUAL DEVICES

			
PRODUCT CODE	41SAI000	41SCI000	41SAB000
DESCRIPTION	Addressable indoor siren for connection in loop.	Addressable indoor siren w/ strobe for conn. in loop	Base with siren for connection to loop
HARDWARE SPECIFICATIONS			
IP RATING	IP43C		IP21C
MATERIAL	ABS	SAN	ABS
NUMBER OF TONE AVAILABLE	32		
GENERAL DATA			
COLOUR	Red	Red, transparent case	White
DIMENSIONS (mm)	116mm, h 55mm		102mm, h 33mm
WEIGHT (g)	183g		127g
CABLE CROSS-SECTION (mm ²)	2.5 mm ²		2mm ²
CERTIFICATION STANDARD	EN54-3, EN54-17	EN54-3, EN54-17, EN54-23	EN54-3
VISUAL SIGNAL		YES	
VISUAL INDICATION COLOUR		White	
OPTICAL SIGNAL COVERAGE EN54-23		W 2,4 - 6m	
TECHNICAL CHARACTERISTICS			
OPERATING RELATIVE HUMIDITY	(93 ± 3)% @ 40°C		
OPERATING TEMPERATURE	-10°C ÷ 50°C		-10°C ÷ 60°C
CONSUMPTION WITH ISOLATOR ACTIVE	<15mA		
RATED CURRENT CONSUMPTION (STAND-BY)	500uA (27 Vdc)		470uA (27 Vdc)
POWER SUPPLY VOLTAGE	15 to 32 Vdc (27 Vdc nominal)		
MAX. CONS. (OTHER TONES) HIGH VOLUME (WITH AUDIO AND STROBE ACTIVE)		< 16.5 mA	
MAX. CONS. (OTHER TONES) HIGH VOLUME (WITH ONLY AUDIO ACTIVE)		<10 mA	
MAX. CONS. (OTHER TONES) HIGH VOLUME	<10mA		
MAX. CONS. (OTHER TONES) LOW VOLUME (WITH AUDIO AND STROBE ACTIVE)		<11mA	
MAX. CONS. (OTHER TONES) LOW VOLUME (WITH ONLY AUDIO ACTIVE)		<4mA	
MAX. CONS. (OTHER TONES) LOW VOLUME	<4mA		
MAX. CONS. MAIN TONE 27 HIGH VOLUME WITH AUDIO AND STROBE ACTIVE		<22mA	
MAX. CONS. MAIN TONE 27 HIGH VOLUME WITH ONLY AUDIO ACTIVE		<16.5 mA	<9,8mA
MAX. CONS. MAIN TONE 27 HIGH VOLUME	<16.5mA		
MAX. CONS. MAIN TONE 27 LOW VOLUME WITH AUDIO AND STROBE ACTIVE		<12mA	
MAX. CONS. MAIN TONE 27 LOW VOLUME WITH ONLY AUDIO ACTIVE		<5mA	< 2.8 mA
MAX. CONS. MAIN TONE 27 LOW VOLUME	<5mA		
SOUND POWER LEVEL (OTHER TONES) HIGH VOLUME (DB@1M)	80÷95dB±3dB@1m		90÷100dB±3dB@1m
SOUND POWER LEVEL (OTHER TONES) LOW VOLUME (DB@1M)	75÷85dB±3dB@1m		82÷92dB±3dB
SOUND POWER LEVEL (MAIN TONE 27) HIGH VOLUME (DB@1M)	92dB±5dB@1m		99dB±4dB
SOUND POWER LEVEL (MAIN TONE 27) LOW VOLUME (DB@1M)	80dB±6dB@1m		92dB±3dB



41BE000

BASE FOR ADDRESSABLE SIRENS IP65
Base IP65 for addressable sounders 41SAI000, and 41SCI000 with cable glands included.



41SAC000



COVER FOR BASES
41SABX00 & 41SCB000
5 plastic covers for 41SABX00 and 41SCB000.







ADDRESSABLE SYSTEM

GUIDE TO FIRE DETECTION

ADDRESSABLE MODULES



			
PRODUCT CODE	4110M040	4110M004	4110M022
DESCRIPTION	Addressable module with four supervised inputs	Addressable module with four relay outputs	Addressable module with 2 supervised inputs and 2 relay outputs
HARDWARE SPECIFICATIONS			
IP RATING	IP40		
PLASTIC	ABS		
NUMBER OF MONITORED INPUTS	4		2
NUMBER OF RELAYS OUTPUTS		4	2
GENERAL DATA			
COLOUR	Grey, transparent cover		
DIMENSIONS (W x H x D)	142x80x45mm		
WEIGHT (g)	230g		
CABLE CROSS SECTION (mm ²)	2mm ²		
CERTIFICATION STANDARD	EN54-17, EN54-18		EN54-18
TECHNICAL CHARACTERISTICS			
OPERATING TEMPERATURE (°C)	-10°C ÷ 60°C		
OPERATING RELATIVE HUMIDITY	(93 ± 3)% @ 40°C		
ELECTRICAL SPECIFICATIONS			
Power consumption 1 led on (mA)	4		3.5
Power consumption in stand-by	300uA@27VDC	175uA@27VDC	235uA@27VDC
Rated power consumption	330uA@27VDC	220uA@27VDC	260uA@27VDC
Output/s maximum current		1A@30VDC/0.5A@125VAC	1A@30VDC/0.5A@125VAC
Power supply voltage	15÷32VDC		
Isolator	YES		

ADDRESSABLE MODULES

				
PRODUCT CODE	411SL000	4110M000	411SC000	4110M010
DESCRIPTION	Short circuit isolator	Addressable module with 1 supervised output	Addressable module for conventional zone	Mini addressable module with one input
HARDWARE SPECIFICATIONS				
IP RATING	IP40			
PLASTIC	PVC autoestinguente	ABS		
NUMBER OF RELAYS OUTPUTS		1 monitored output		
GENERAL DATA				
COLOUR	White	Grey, transparent cover		
DIMENSIONS (W X H X D)	71x71x40mm	142x80x45mm		43x25
WEIGHT (g)	185g	230g		
MAXIMUM INSULATOR RESISTANCE	0,18 27Vcc 0,25 15Vcc			
CABLE CROSS SECTION	2mm ²	2,5mm ²		
CERTIFICATION STANDARD	EN54-17	EN54-17, EN54-18	EN54-18	
TECHNICAL CHARACTERISTICS				
OPERATING TEMPERATURE (°C)	-10°C ÷ 60°C			
OPERATING RELATIVE HUMIDITY	(93 ± 3)% @ 40°C			
ELECTRICAL SPECIFICATIONS				
POWER CONSUMPTION 1 LED ON	3.0 mA	3.6 mA	3 mA	
POWER CONSUMPTION IN STAND-BY	200uA@27VDC	270uA@27Vdc	5,5mA@27Vdc	
SHORT-CIRCUIT CONSUMPTION	16mA			
RATED POWER CONSUMPTION	200uA@27VDC	270uA@27Vdc		
OUTPUT/S MAXIMUM CURRENT		0.75A@ 28VDC/0.5A@120Vac		
POWER SUPPLY VOLTAGE	15÷32Vdc			
ISOLATOR	Yes			

ADDRESSABLE
SYSTEM

BEAM DETECTORS

			
PRODUCT CODE	48BFC000	48BFC002	48BFC003
DESCRIPTION		Beam detector with reflector 5-50 m	Beam detector with reflector 50-100 m
FUNCTIONS			
LED INDICATIONS	1,180° visibility	1,95° visibility	
HARDWARE SPECIFICATIONS			
IP RATING	IP41		
MATERIAL	ABS		
GENERAL DATA			
COLOUR	White		
DIMENSIONS (IN MM) LXHXD	115x115x78	128x80x84	
WEIGHT (g)	700 g	350 g	
CABLE CROSS SECTION (mm ²)	1.5		
CERTIFICATION STANDARD	EN54-12		
BASE	130x150mm		
OPTICAL CHARACTERISTICS			
WAVELENGTH (nm)	940		
DISTANCE (m)	3 - 30	5 - 50	50-100
MAX. ANGULAR MISALIGNMENT OF THE DETECTOR (±, °)	0.35	0.5	
MAX. ANGULAR MISALIGNMENT OF THE REFLECTOR (±, °)	5		
MAX. ANGULAR MOVEMENT OF THE DETECTOR (±, °)	1.8		
FAULT THRESHOLD (%)	92		
TECHNICAL CHARACTERISTICS			
OPERATING TEMPERATURE (°C)	-10 to 55	-25 to 55	
OPERATING RELATIVE HUMIDITY (%)	95 % without condensation	95% @ + 40°C	
ELECTRICAL SPECIFICATIONS			
MAIN POWER SUPPLY (VDC)	13 to 28 Vdc	9.5 to 28 Vdc	9.5 to 29 Vdc
CURRENT CONSUMPTION IN ALARM STATE	20		
STANDBY CURRENT (@24VDC - mA)	2,8 mA	8 to 30 mA	
CURRENT IN ALARM (@24VDC - mA)	12 mA	20 to 100 mA	



48BFA006 SPARE REFLECTOR FOR 48BFC003
Spare reflector for linear smoke detector 48BFC003



48BFA004 SPARE REFLECTOR FOR 48BFC002
Spare reflector for linear smoke detector 48BFC002



48BFA003 FLUSH MOUNT BOX FOR BARRIER 48BFC000
Accessory for flush mounting of barrier 48BFC000.







48BFA005 ALARM TEST INSTRUMENT FOR 48BFC002 AND 48BFC003
Alarm test instrument for barrier 48BFC002 and 48BFC003; this is a filter for ALARM simulation and for checking that the fire barriers are calibrated correctly





COMMON ACCESSORIES

GUIDE TO FIRE DETECTION

VISUAL AND AUDIBLE WARNING DEVICES

								
PRODUCT CODE	48SCI040	48SCI060	48SAI020	48LMI000	48SCI000	48LMI020	48SCI020	
DESCRIPTION	Sounder with red strobe	Sounder with white strobe	Indoor 32 tone siren	Ceiling-mounted strobe - IP21 - white flash	Ceiling-mounted siren and strobe - IP21 - white flash	Wall-mounted strobe - IP21 - white flash	Wall-mounted siren and strobe - IP21 - white flash	
MAIN SPECIFICATIONS								
FREQUENCY BAND				400 - 2900 Hz			400 - 2900 Hz	
HARDWARE SPECIFICATIONS								
IP RATING	IP21C			IP21				
MATERIAL	SAN		ABS	High Impact Polycarbonate				
NUMBER OF TONE AVAILABLE	32						32	32
GENERAL DATA								
COLOUR	Transparent Red	Transparent White	Red					
DIMENSIONS (mm)	102 (ø) x 32 (H)			100 (ø) x 94 (H)		100 (ø) x 100 (H)		
WEIGHT (g)	248g							
CABLE CROSS-SECTION (mm ²)	2.0mm ²	1.5mm ²						
CERTIFICATION STANDARD	EN54-3	EN54-3, EN54-23	EN54-3	EN54-23, LPCB	EN54-3, EN54-23, LPCB	EN54-23, LPCB	EN54-3, EN54-23, LPCB	
VISUAL SIGNAL	Yes			Yes				
VISUAL INDICATION COLOUR	Red	White	White					
AUDIBLE SIGNAL (LOW LEVEL - dB@1m)	94			94		94		
AUDIBLE SIGNAL (HIGH LEVEL - dB@1m)	102							
OPTICAL SIGNAL COVERAGE EN54-23	(O) 2,3 - 1,5 - 0,75		(C) 3 x 15m			(W) 3,1 x11,3m		
TECHNICAL CHARACTERISTICS								
OPERATING RELATIVE HUMIDITY	(93 ± 3)% @ 40°C			< 95%				
OPERATING TEMPERATURE	-10°C +60°C			-25°C +70°C	-10°C +55°C	-25°C +70°C	-10°C +55°C	
FLASHING FREQUENCY	1Hz			1Hz				
ELECTRICAL SPECIFICATIONS								
POWER SUPPLY VOLTAGE	20÷28 Vdc			17÷60 Vdc				
MAX. CONS. (OTHER TONES) HIGH VOLUME (WITH AUDIO/STROBE ACTIVE)	25mA							
MAX. CONS. (OTHER TONES) HIGH VOLUME (WITH ONLY AUDIO ACTIVE)	22mA							
MAX. CONS. (OTHER TONES) LOW VOLUME (WITH AUDIO/STROBE ACTIVE)	12 mA							
MAX. CONS. (OTHER TONES) LOW VOLUME (WITH ONLY AUDIO ACTIVE)	8.5 mA							
MAX. CURR. CONS. (VISUAL/AUDIBLE ALARM)				20mA-0.5Hz, 40mA-1Hz (24V DC)	25mA at 0.5Hz, 45mA at 1Hz	20mA-0.5Hz, 40mA-1Hz (24V DC)	25mA at 0.5Hz, 45mA at 1Hz	
MAX. CONS. MAIN TONE 27 HIGH VOLUME WITH ONLY AUDIO ACTIVE				22 mA @ 24 VDC				
MAX. CONS. MAIN TONE 27 HIGH VOLUME				22 mA @ 24 VDC				
MAX. CONS. MAIN TONE 27 LOW VOLUME				8.5 mA @ 24 VDC				
SOUND POWER LEVEL (OTHER TONES) HIGH VOLUME (DB@1M)	83-102dB	95-104dB	90-102dB	97dB (A)		97dB (A)		
SOUND POWER LEVEL (MAIN TONE 27) HIGH VOLUME (DB@1M)	92-101dB	95-104dB	102dB					

						
48LME000	48SCE000	48LME020	48SCE020	48CME000	48CMI000	48SAE000
Ceiling-mounted strobe - IP65 - white flash	Ceiling-mounted siren and strobe - IP65 - white flash	Wall-mounted strobe - IP65 - white flash	Wall-mounted siren and strobe - IP65 - white flash	6" Outdoor alarm bell, 24 Vdc 12mA EN54	6" Indoor alarm bell, 24 Vdc 12mA EN54	Electronic siren, IP66 EN54
	400 - 2900 Hz		400 - 2900 Hz			
	IP65			IP55	IP33C	IP65 CON STAFFA DI FISSAGGIO 48SAE001
	High Impact Polycarbonate			Aluminium		ABS
	32		32	1		32
	Red					
97.5 (ø) x 117 (H)		97.5 (ø) x 122 (H)		150 (ø) x 64 (H)	150 (ø) x 53 (H)	95 (ø) x 92 (H)
				780g	410g	
						2.5mm ²
EN54-23, LPCB	EN54-3, EN54-23, LPCB	EN54-23, LPCB	EN54-3, EN54-23, LPCB	EN54-3	EN54-3	
	Yes					
	White					
	94			94		
(C) 3 x 15m		(W) 3,1 x 11,3m				
	<95%			45% / 85%		
-25°C +70°C	-10°C +55°C	-25°C +70°C	-10°C +55°C	-10°C +50°C		-40°C +70°C
	1Hz					
	17-60Vdc			20.4-27.6Vdc	24Vdc	9-30Vdc
20mA-0.5Hz, 40mA-1Hz (24V DC)	25mA at 0.5Hz, 45mA at 1Hz	20mA-0.5Hz, 40mA-1Hz (24V DC) SOLO LAMPEGGIANTE	25mA at 0.5Hz, 45mA at 1Hz	12mA	11mA	39mA
		97dB (A)		100±5dB (A)	95dB (A)	110dB

DUCT DETECTOR



48CAC001

TEST CHAMBER FOR DUCTS

Test chamber designed to house a analogue or conventional detector for the testing of ventilation ducts; uses the Pitot tube principle to continuously sample air circulating through the duct and analyse it using the smoke detector housed in the chamber. IT is suitable for analysing air circulating in ducts in which the air flow velocity is between 1m/s and 10 m/s. Positioned inside the duct, the test chamber has an air inlet pipe and an outlet pipe; inside the test chamber the detector analyses the sampled air. To be used in conjunction with a base and an analogue or conventional smoke detector.



48SAE001

BACKPLATE FOR 48SAE000 SIREN IP66 MOUNTING

Mounting backplate for the siren 48SAE000 with IP66 protection rating.



COMMON ACCESSORIES

GUIDE TO FIRE DETECTION

DOOR HOLDERS



48FME051

50 KG DOOR HOLDER

Electromagnet with 50 kg holding force for fire doors. Can be wall or floor mounted, with optional backplate (art. 48FMA03). Automatic release in the event of fire. Manual release button included. Connection terminals, equipped with diode for protection against inverse polarity and current limiting resistor. Quick-fix keeper plate. Nickel-plated steel body for maximum corrosion resistance. Fibreglass-reinforced thermoplastic base. Power supply 24 Vdc. Absorption 50 mA. Low current consumption mode. EN 1155 approved.



48FME052

50 KG DOOR HOLDER - 15 CM WALL/FLOOR BRACKET

Door holder with 50 kg holding force for fire doors. Can be wall or floor mounted. Automatic release in the event of fire. Manual release button included. Connection terminals, equipped with diode for protection against inverse polarity and current limiting resistor. Quick-fix keeper plate. Nickel-plated steel body for maximum corrosion resistance. Fibreglass-reinforced thermoplastic base. 24Vdc power supply. Current consumption 50 mA. Low current consumption mode. 15 cm wall or floor bracket. EN 1155 approved.



48FME053

50 KG DOOR HOLDER - 30 CM WALL/FLOOR BRACKET

Door holder with 50 kg holding force for fire doors. Can be wall or floor mounted. Automatic release in the event of fire. Manual release button included. Connection terminals, equipped with diode for protection against inverse polarity and current limiting resistor. Quick-fix keeper plate. Nickel-plated steel body for maximum corrosion resistance. Fibreglass-reinforced thermoplastic base. 24Vdc power supply. Current consumption 50 mA. Low current consumption mode. 30 cm wall or floor backplate. EN 1155 approved.



48FME101

100 KG DOOR HOLDER

Door holder with 100 kg holding force for fire doors. Can be wall or floor mounted, with optional backplate (art. 48FMA03). Automatic release in the event of fire. Manual release button included. Connection terminals, equipped with diode for protection against inverse polarity and current limiting resistor. Quick-fix keeper plate. Nickel-plated steel body for maximum corrosion resistance. Fibreglass-reinforced thermoplastic base. 24Vdc power supply. Current consumption 100mA Low current consumption mode. EN 1155 approved.



48FMA01

ALUMINIUM COVER FOR 48FME051

Aluminium cover for door holder 48FME051.



48FMA02

ALUMINIUM COVER FOR 48FME101

Aluminium cover for door holder 48FME101.



48FMA03

FLOOR-STANDING BACKPLATE FOR 48FME051 AND 48FME101

Aluminium backplate for floor mounting of door holders 48FME051 and 48FME101.

ACCESSORIES



48CVI115 FIRE CABLE EN50200 CEI20-105 PH30 2X1.5 100 M
Fire-resistant cable for fire detection systems, length 100 m, cross-section 2x1.5.
Approved to EN50200 CEI20-105.

48CVI125 FIRE CABLE EN50200 CEI20-105 PH30 2X2.5 100M
Fire-resistant cable for fire detection systems, length 100 m, cross-section 2x2.5.
Approved to EN50200 CEI20-106.



48ALM000 ADDITIONAL POWER SUPPLY UNIT 2A
Power supply unit designed to provide auxiliary power. IP30 rated metal enclosure. Total available current: 2A. Available output current: 1.5 A. Current available for battery charging: 0.5A. Maximum recommended capacity for battery housing (with connection in series) 2 x 12V 12Ah. Power supply voltage: 230 Vac. Output voltage: 27.5 Vdc (with batteries not connected). Dimensions: 405 x 385 x 160mm. The power supply unit is equipped with 2 outputs with volt-free relays for the signals required by EN54-4.
Approved to EN 54-4, EN 12101-10.



48ALM001 ADDITIONAL POWER SUPPLY UNIT 4A
Power supply unit designed to provide auxiliary power. IP30 rated metal enclosure. Total available current: 4A. Available output current: 3A. Current available for battery charging: 1A Maximum recommended capacity for battery housing (with connection in series) 2 x 12V 24Ah. Power supply voltage: 230 Vac. Output voltage: 27.5 Vdc (with batteries not connected). Dimensions: 405 x 385 x 160mm. The power supply unit is equipped with 2 outputs with volt-free relays for the signals required by EN54-4.
Approved to EN 54-4, EN 12101-10.



30076003 12V DC / 7 AH LEAD BATTERY
Lead battery in AGM technology. 12 Vdc / 7Ah. Each battery cell is equipped with a one-way safety valve that guarantees the disposal of possible overpressures of internal gas.
Dimensions: 151x100x65mm

30076004 12V DC / 18 AH LEAD BATTERY
Lead battery in AGM technology. 12 Vdc / 18Ah. Each battery cell is equipped with a one-way safety valve that guarantees the disposal of possible overpressures of internal gas.
Dimensions: 181x168x76 mm

30076005 12V DC / 27 AH LEAD BATTERY
Lead battery in AGM technology. 12 Vdc / 27Ah. Each battery cell is equipped with a one-way safety valve that guarantees the disposal of possible overpressures of internal gas.
Dimensions: 166x175x125 mm

30076006 12V DC / 40 AH LEAD BATTERY
Lead battery in AGM technology. 12 Vdc / 40Ah. Each battery cell is equipped with a one-way safety valve that guarantees the disposal of possible overpressures of internal gas.
Dimensions: 197x165x170 mm



48CCB000 METAL HOUSING FOR ADDITIONAL BATTERIES
Metal housing for additional batteries Can accommodate 2x 12V - 18 Ah batteries.
Dimensions: 410 x 310 x 85mm.



48SDT001 AEROSOL FOR SMOKE DETECTOR TESTING
Aerosol for smoke detector testing.



ASPIRATING SYSTEM

GUIDE TO FIRE DETECTION

ASPIRATING UNITS

			
PRODUCT CODE	ILS-1	ILS-2	IFT-P
DESCRIPTION	Aspirating unit, 1 zone, 1 detector, 1 channel	Aspirating unit, 1 zone, 2 detectors, 2 channels	Aspirating unit, 1 zone, 1 detector, 2 channels
MAIN FEATURES			
DETECTION ELEMENTS	1 o 2 points detector	2 points detectors	Single-zone laser detector with double thermal element
AREA COVERAGE (m ²)	2000		
OUTSIDE DIAMETER	25mm		
INSIDE DIAMETER	21mm		
PIPE NETWORK	1 inlet - 100m	2 inlet - 100m	
SENSITIVITY	0.06 to 6.0%obs/m		0.001 to 20%obs/m
CLASS A SAMPLING HOLES	3		12 (0.04% obs/m)
CLASS B SAMPLING HOLES	6		36 (0.04 obs/m)
CLASS C SAMPLING HOLES	18		36 (0.1% obs/m)
CERTIFICATION STANDARD	EN54-20 (VdS)		EN54-20 (VdS), NF, UL, FM, ULC, CCC
CONNECTIVITY	RS485, TCP/IP		
EVENT LOG	20000		
HARDWARE SPECIFICATIONS			
DIMENSIONS	259x184x166mm		254x180x165mm
IP RATING	IP65		
GENERAL DATA			
OPERATING TEMPERATURE (°C)	50		39
RH OPERATING HUMIDITY (%)	95		
FILTER	Internal serviceable filter (external filter optional)		Replaceable dual stage
FLOW MONITORING	Programmable on 2 levels (high/low)		Twin thermal element
ASPIRATOR CONTROLLER	10 programmable speed		
ELECTRICAL SPECIFICATIONS			
POWER SUPPLY VOLTAGE	24 VDC		
MAX ABSORPTION (W)	7.20		30
CURRENT CONSUMPTION (mA)	350		500
RELAYS	3 (Fault/Action/Fire), 1A@30 VDC (N.C./N.O.)	6 (Fault/Action/Fire), 1A@30 VDC (N.C./N.O.)	Contacts 1A@30Vdc, NO/NC. 4 alarm relays, 1 fault relay
POWER SUPPLY CONNECTIONS	18AWG min (16x0,25mm)		
CONNECTIONS FROM FIELD	11AWG max.(2.5mm diameter)		
USB	Standard type B USB cable		

ASPIRATION ACCESSORIES

15 METER PIPE AND ACCESSORIES KIT

Pipe and accessories kit comprising:
 5x 3 meter lengths of red ABS 25 mm pipe, art. PIP-001,
 2 packs of 10 pcs. connection sockets for 25 mm pipe, art. PIP-002,
 1 pack of 10 pcs. 90° bend for 25mm pipe, art. PIP-005,
 1 pack of 10 pcs. 45° bend for 25mm pipe, art. PIP-006,
 1 pack of 10 pcs. end cap for 25mm pipe, art. PIP-007,
 1 pack of 20 pcs clips for 25mm pipe, art. PIP-009,
 100 pcs. rectangular sampling point label, art. 128-046.

















PKIT-15-E



30 METER PIPE AND ACCESSORIES KIT

Pipe and accessories kit comprising:
 10x 3 meter lengths of red ABS 25 mm pipe, art. PIP-001,
 3 packs of 10 pcs. connection sockets for 25 mm pipe, art. PIP-002,
 1 pack of 10 pcs. 90° bend for 25mm pipe, art. PIP-005,
 1 pack of 10 pcs. 45° bend for 25mm pipe, art. PIP-006,
 1 pack of 10 pcs. end cap for 25mm pipe, art. PIP-007,
 2 packs of 20 pcs. clips for 25mm pipe, art. PIP-009,
 100 pcs. rectangular sampling point label, art. 128-046.















PKIT-30-E

	<p>PKIT-60-E 60 METER PIPE AND ACCESSORIES KIT Pipe and accessories kit comprising: 20x 3 meter lengths of red ABS 25 mm pipe, art. PIP-001, 4 packs of 10 pcs. connection sockets for 25 mm pipe, art. PIP-002, 1 pack of 10 pcs. 90° bend for 25mm pipe, art. PIP-005, 1 pack of 10 pcs. 45° bend for 25mm pipe, art. PIP-006, 1 pack of 10 pcs. end cap for 25mm pipe, art. PIP-007, 3 packs of 20 pcs. clips for 25mm pipe, art. PIP-009, 100 pcs. rectangular sampling point label, art. 128-046.</p>
	<p>PIP-001 RED ABS 25 MM PIPE, 20X 3 METERS 20x 3 meter lengths of RAL3000 ABS 25 mm pipe.</p>
	<p>PIP-002 CONNECTION SOCKET 25MM (10 PCS) Connection socket 25mm (10 pieces)</p>
	<p>PIP-003 SOCKET UNION FOR 25MM (10 PCS) Socket union 25mm (10 pieces)</p>
	<p>PIP-005 90 ELBOW FOR 25MM (10 PCS) 90° elbow for 25mm (10 pieces)</p>
	<p>PIP-006 45 ELBOW FOR 25MM PIPE (10 PCS) 45° elbow for 25mm pipe (10 pieces)</p>
	<p>PIP-007 END CAP FOR 25MM PIPE (10 PCS) End cap for 25mm pipe (10 pieces)</p>
	<p>PIP-008 EQUAL TEE FOR 25MM PIPE (10 PCS) Equal Tee for 25mm pipe (10 pieces)</p>
	<p>PIP-009 CLIP FOR 25MM PIPE (20 PCS) Clip for 25mm pipe (20 pieces)</p>
	<p>PIP-014 PIPE CUTTERS Pipe cutters (1 piece)</p>
	<p>059-007 CONICAL SAMPLE POINT KIT AND 2M TUBE Conical sample point kit and 2 meter length of 10 mm pipe (1 piece).</p>
	<p>059-001 FLUSH SAMPLE POINT KIT AND 2M PIPE Flush sample point kit and 2 meter length of 10 pipe (1 piece).</p>
	<p>144-013 CONICAL SAMPLE POINT HEAD Conical sample point head</p>
	<p>PIP-015 FLUSH SAMPLE POINT HEAD FOR CAPILLARY PIPE Flush sample point head for capillary pipe (1 piece)</p>
	<p>PIP-016 TEE ADAPTER FOR CAPILLARY PIPE (10 PCS) Tee adapter for capillary pipe (10 pieces).</p>
	<p>PIP-027 REMOTE SAMPLING TEST POINT FOR CAPILLARY TUBE Remote sampling test point for 10 mm capillary tube (1 piece).</p>



ASPIRATING SYSTEM

GUIDE TO FIRE DETECTION

	PIP-026	25MM FLEXIBLE CONNECTOR, 30 CM 25mm flexible connector, 30 cm (1 piece).
	PIP-021	25MM FLEXIBLE CONNECTOR, 100 CM 25mm flexible connector, 100 cm (1 piece).
	PIP-025	WATER FILTER WITH TRANSPARENT PIPE AND VALVE Water trap with clear pipe and ball valve (1 piece).
	222-059	DISCREET END CAP FOR CAPILLARY PIPE (10 PCS) End cap for capillary pipe (10 pieces)
	221-035	RED 10MM CAPILLARY PIPE (100M) RAL3000 10mm capillary pipe (100m reel)
	221-036	CLEAR 10MM CAPILLARY PIPE (100M) Clear 10mm capillary tube (100m reel)
	128-014	ROUND SAMPLING POINT LABEL (100 PCS) Round sampling point label (100 pieces on roll).
	128-046	RECTANGULAR SAMPLING POINT LABEL (100 PCS) Rectangular sampling point label (100 pieces on roll).
	128-015	SMOKE DETECTOR PIPE LABEL (100 PCS) Smoke detector pipe label (100 pieces).
	VSP-850-R	25MM IN-LINE EXTERNAL FILTER - RED 25 mm external in-line filter - Red - to be used for installation of aspirating detectors in contaminated environments such as sawmills, scrapyards, etc.. The internal filter elements must be replaced periodically.
	VSP-855-4	REPLACEMENT FOR FILTER VSP-850-R - 4 PIECES Replacement filter elements for external in-line filter VSP-850. Pack of 4 filter elements.
	02-FL53	REPLACEMENT FILTER ELEMENT, ILS1/2 AND IFT-P 10 PCS Replacement filter elements for aspirating detectors ILS-1, ILS-2 and IFT-P (20 ppi). For the IFT-P detector, this filter element can replace the first stage filter. Pack of 10 pieces.
	02-FL56	REPLACEMENT FILTER ELEMENT, IFT-P STAGE 2, 10 PCS Full description: Replacement filter elements for aspirating detector IFT-P (45 ppi). Replaces the second stage filter. Pack of 10 units.
	COLL250	ADHESIVE FOR PIPES AND SOCKETS 250ML Adhesive for bonding pipes and fittings. Supplied with applicator brush. Contents: 250ml.

WIRELESS EXPANSION
GUIDE TO FIRE DETECTION

WIRELESS EXPANSION



45TRS000

WIRELESS SIGNAL TRANSLATOR FOR CONVENTIONAL ZONE

The translator module allows interfacing between the conventional zone of the wired system and the wireless system. Communication via two-way radio guarantees excellent reliability. Automatic optimisation of the frequency and communication level, automatic channel selection. It can manage up to 32 devices via radio (sensors, buttons, sirens, etc.). Allows easy integration between radio systems and wired systems. Programmable from device or from a PC via RS232, by means of configuration software. EN 54-17, EN 54-18 and EN 54-25 approved.



45RPT000

WIRELESS SIGNAL REPEATER FOR RADIO SYSTEM

The wireless repeater module, connected to a translator module or another repeater module, makes it possible to extend the coverage area of the radio system, allowing installation of the wireless system in difficult environments. Two-way communication between the expander and translator guarantees optimum reliability. It is easily configured via RS232 using the configuration software, or via the keypad on the device itself. It automatically optimises the communication frequency and level; the channel is selected automatically. It can manage up to 32 devices via radio (sensors, buttons, sirens, etc.). External power supply. EN 54-18 and EN 54-25 approved.



45RFU000

WIRELESS OPTICAL SMOKE DETECTOR

Wireless optical Tyndall-effect smoke detector. The digital signal processing algorithms make it particularly sensitive to detecting smoke, even in the early stages of a fire breaking out. Two-way radio communication. Immediate transmission in the event of an alarm, fault or removal. Monitored dual battery for backup. Two-tone LED with 360° visibility. Option of conducting the test with a magnet. 21C IP rating. Operating temperature -30°C / +55°C. Weight 130 g. Dimensions 110 x 65 mm. EN 54-7 and EN 54-25 approved. Base included.



45RML000

WIRELESS MULTI-CRITERION DETECTOR

Wireless multi-criteria detector. Combines the detection modes of a heat detector and an optical smoke detector, and is therefore particularly suited to applications where early fire detection must be ultra-reliable (hotels, museums, etc.). The detector signals the alarm if the smoke or temperature threshold is exceeded. Two-way radio communication. Immediate transmission in the event of an alarm, fault or removal. Monitored dual battery for backup. Two-tone LED with 360° visibility. Option of conducting the test with a magnet. 21C IP rating. Operating temperature -30°C / +55°C. Weight 130 g. Dimensions 110 x 65 mm. EN 54-5, EN 54-7 and EN 54-25 approved. Base included.



45RCS000

WIRELESS THERMAL DETECTOR

Wireless heat detector. Can detect the fixed threshold of 58°C in addition to rapid changes in temperature ("rate of rise") as set out by standard EN 54-5 for class A1R. The control algorithms implemented also mean it can be used in environments which are subject to ambient temperature changes; it is particularly useful for dusty or dirty environments or where the humidity level is high, factors which may negatively impact the performance of the optical sensors. Two-way radio communication. Immediate transmission in the event of an alarm, fault or removal. Monitored dual battery for backup. Two-tone LED with 360° visibility. Option of conducting the test with a magnet. 21C IP rating. Operating temperature -30°C / +55°C. Weight 130 g. Dimensions 110 x 65 mm. EN 54-5 and EN 54-25 approved. Base included.



45PAM000

MANUAL WIRELESS ALARM POINT

Wireless manual call point. The button is equipped with a resettable special plastic key element (supplied) and sends an alarm signal when it is activated by pressing the indicated point. It is equipped with an LED for signalling the status. Two-way radio communication. Wall mounting. Monitored dual battery for backup. Immediate transmission in the event of an alarm, fault or removal. Operating temperature -30°C / +55°C. Weight 186 g. Dimensions 86x86x59 mm. EN 54-11 and EN 54-25 approved.



45SAI020

WIRELESS WALL-MOUNTED SIREN

Wall-mounted siren, to be completed with module 45MOD000, which makes it suitable for use in wireless systems with EN54-25 approval; the siren has 3 volume adjustment levels and 32 different tones which can be set locally via dip-switch. Sound power 100db. Approved to EN54-3.



45SCI000

WIRELESS SIREN WITH FLASHING LIGHT

Siren with strobe for wall mounting. To be completed with module 45MOD000, which makes it suitable for use in wireless systems with EN54-25 approval. Equipped with dip-switches for selecting one of the 32 available tones, with the option of setting the flashing frequency between 0.5 Hz and 1 Hz. IP65 protection rating. EN54-3 EN54-23 approved.



45MOD000

MODULE FOR WIRELESS SIREN

RF transceiver module to be installed directly inside the wireless sirens to allow communication with the translators/repeaters. Max distance between the translators/repeaters and the module: 150m. Main battery lifespan: 5 years. Secondary battery lifespan: 2 months. EN54-18 and EN54-25 approved.



45SAB000

BASE WITH WIRELESS SIREN

Base with wireless siren with two-way radio communication. Suitable for housing a wireless detector. Monitored dual battery for backup. Immediate transmission in the event of an alarm, fault or removal of the sensor. 32 tone options. Max. sound power 97 dBa. Communication distance in open air 200 m. Weight: 130 g. Dimensions 145 x 66 mm. EN 54-3 and EN 54-25 approved.



WIRELESS EXPANSION



45SAC000 COVER FOR BASE WITH WIRELESS SIREN
Cover to be applied to the base with siren 45SAB000 if a detector is not fitted.



45FPT000 REMOTE WIRELESS SIGNALLING UNIT
The remote indicator repeats the status of the wireless detectors. Compatible with sensors that support this function. Two-way radio communication, monitored dual battery for backup. Operating temperature -10°C / +55°C. Weight 130 g. Dimensions: 145 x 66 mm.



45PAK000 SPARE KEY FOR 45PAM000
Spare key for manual wireless button 45PAM000.

ATEX SYSTEM

GUIDE TO FIRE DETECTION

ATEX



48BAZ000 ZENER BARRIER FOR ATEX DETECTORS
Zener barrier certified as an intrinsically safe electrical system. Specifically designed for use with our detector 48RCX000 and manual call button 48PAX000. Voltage: 24Vdc Dimensions: 104 x 70 x 12.2 mm. **Certified to CE 0081 II (1/2) G [Eex ia/ib] IIC/IIB/PTB 01 ATEX 2088 standards.**

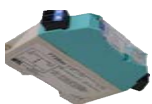

48BAZ001 ZENER BARRIER FOR ATEX SIREN
Zener barrier certified as an intrinsically safe electrical system. Specifically designed for use with our siren 48SAX00. Voltage: 15-28Vdc. Dimensions: 70 x 80 x 10 mm. **Certified to CE 0359 II (1) GD [Eex ia] IIC/BAS 01 ATEX 7005 standards.**



48RBX000 MOUNTING BASE FOR ATEX DETECTORS
Mounting base for ATEX detectors 48RCX000.



48RCX000 ATEX HEAT-RATE OF RISE DETECTOR
59°C temperature detector and 9°C/min rate-of-rise detector with 59°C static safety for zones with atmospheres with high risk of explosion. Voltage: 12-30Vdc Current consumption on stand-by: 120µA. **Approved to CE 0081 II 1 G Eex ia IIC T6/LCIE 03 ATEX 6350 X.**



48SAX000 ATEX SIREN
Siren for use in areas with atmospheres with high risk of explosion to be used in conjunction the Zener barrier 48BAZ001. Operating voltage: 15-28Vdc. **Approved to CE 0359 II 1 G Eex ia IIC T4/BAS 00 ATEX 1181.**



48PAX000 ATEX ALARM BUTTON
Manual call point for use in atmospheres with high risk of explosion. Activated mechanically by pressing on the front window. Includes an operating element that can be reset with the aid of special key. Operating voltage: 13 to 28Vdc Current consumption: 150 µA. **Approved to EN 60079-0 (09), EN 60079-11 (07) and conforming to directives ATEX 94/9/EC.**

FIRE DETECTION INDEX - 1 OF 2

43CPC016EN	ERACLE CONVENTIONAL FIRE DETECTION PANEL WITH 8 TO 16 ZONES	28
43CPC008EN	ERACLE CONVENTIONAL FIRE ALARM CONTROL PANEL WITH 8 ZONES	28
43CPC004EN	ERACLE CONVENTIONAL FIRE ALARM CONTROL PANEL WITH 4 ZONES	28
43CPC002EN	ERACLE CONVENTIONAL FIRE ALARM CONTROL PANEL WITH 2 ZONES	28
43ECR032	EXPANSION MODULE WITH 8 RELAYS FOR ERACLE 8	29
43CRE000	SET OF 5 PAIRS OF KEYS FOR ERACLE CONTROL PANEL	29
43EOL000	SET OF 5 END-OF-LINE RES. FOR CONVENTIONAL ZONE	29
43LEC000	EVENTS LOG FOR ERACLE 8 AND ERACLE 16	29
43ECZ020	4 ZONE EXPANSION MODULE FOR ERACLE 16	29
43ECS020	4-SIREN EXPANSION MODULE FOR ERACLE 16	29
43RCS000	CONVENTIONAL HEAT AND RATE-OF-RISE DETECTOR, FIXED THRESHOLD 58°	30
43RCS001	CONVENTIONAL HEAT DETECTOR, FIXED THRESHOLD 60°	30
43RFU000	CONVENTIONAL OPTICAL SMOKE DETECTOR	30
43RML000	CONVENTIONAL MULTI-CRITERIA SMOKE/HEAT DETECTOR	30
43PAM000	CONVENTIONAL MANUAL CALL POINT	31
43PAE020	OUTDOOR CONVENTIONAL MANUAL CALL POINT, IP67	31
43RBX000	BASE FOR CONVENTIONAL SENSORS	31
43RBX001	BASE WITH DIODE FOR CONVENTIONAL SENSORS	31
43RBX003	BASE WITH RELAY FOR CONVENTIONAL SENSORS	31
43RBA002	SPACER FOR CONVENTIONAL SENSORS	31
43PAK000	SPARE KEY FOR 41PAM000 AND 43PAM000.	31-34
41BSE000	BASE FOR ADDRESSABLE SIRENS IP65	35
41CPE012	ATENA EASY EXPANDABLE ADDRESSABLE FIRE ALARM CONTROL PANEL	32
41CPE024EN	ATENA EXPANDABLE ADDRESSABLE FIRE ALARM CONTROL PANEL	32
41ECL022	1 LOOP EXP. CARD FOR ATENA EASY ADDRESSABLE CONTROL PANEL	33
41ECL020	1 LOOP EXPANSION CARD FOR ATENA ADDRESSABLE CONTROL PANEL	33
41ECB000	EXP. CARD REDUNDANT BUS FOR ATENA + ATENA EASY CONTROL PANELS	33
41CPR000	REPEATER PANEL FOR ATENA AND ATENA EASY CONTROL PANELS	33
41SAC000	PLASTIC COVER FOR 41SABX00 AND 41SCB000	35
41SPG000	PROGRAMMING DEVICE FOR ADDRESSABLE DEVICES	33
41SWS000	ATENA MANAGER SUPERVISION SOFTWARE	33
41RCS000	ADDRESSABLE HEAT DETECTOR WITH ISOLATOR	34
41RFU000	ADDRESSABLE OPTICAL SMOKE DETECTOR WITH ISOLATOR	34
41RML000	ADDRESSABLE MULTI-CRITERIA SMOKE/HEAT DETECTOR WITH ISOLATOR	34
41PAM000	ADDRESSABLE MANUAL CALL POINT	34
41PAE020	ADDRESSABLE MANUAL CALL POINT, IP67	34
41RBX020	BASE FOR ADDRESSABLE SENSORS	34
43PAK000	SPARE KEY FOR 41PAM000 AND 43PAM000.	31-34
41IOM040	ADDRESSABLE MODULE WITH FOUR SUPERVISED INPUTS	36
41IOM004	ADDRESSABLE MODULE WITH FOUR RELAY OUTPUTS	36
41IOM022	ADDRESSABLE MOD.W/ 2 SUPERVISED INP.+2 RELAY OUTP.	36
41ISL000	SHORT-CIRCUIT ISOLATOR	36
41IOM000	ADDRESSABLE MODULE WITH 1 SUPERVISED OUTPUT	36
41ISC000	ADDRESSABLE MODULE FOR CONVENTIONAL ZONE	36
41IOM010	ADDRESSABLE MINI MODULE WITH 1 INPUT	36
41SAI000	ADDRESSABLE INDOOR SIREN FOR CONNECTION TO LOOP	35
41SCI000	ADDRESSABLE INDOOR SIREN W/ FLASHING LIGHT FOR CONN. IN LOOP	35
41SAB000	BASE WITH SIREN FOR CONNECTION TO LOOP	35



FIRE DETECTION INDEX - 2 OF 2

48BFC000	LINEAR SMOKE DETECTOR WITH REFLECTOR 3-30 M	37
48BFC002	LINEAR SMOKE DETECTOR WITH REFLECTOR 5-50M	37
48BFC003	LINEAR SMOKE DETECTOR WITH REFLECTOR 50-100M	37
48BFA003	FLUSH MOUNT BOX FOR BARRIER 48BFC000	37
48BFA004	SPARE REFLECTOR FOR 48BFC002	37
48BFA005	ALARM TEST INSTRUMENT FOR 48BFC002	37
48BFA006	SPARE REFLECTOR FOR 48BFC003	37
48LMI000	CEILING-MOUNTED STROBE - IP21 - WHITE FLASH	38
48SCI000	CEILING-MOUNTED SIREN AND STROBE - IP21 - WHITE FLASH	38
48LMI020	WALL-MOUNTED STROBE - IP21 - WHITE FLASH	38
48SCI020	WALL-MOUNTED SIREN AND STROBE - IP21 - WHITE FLASH	38
48SCI040	SOUNDER WITH RED STROBE	38
48SCI060	SOUNDER WITH WHITE STROBE	38
48LME000	CEILING-MOUNTED STROBE - IP65 - WHITE FLASH	39
48SCE000	CEILING-MOUNTED SIREN AND STROBE - IP65 - WHITE FLASH	39
48LME020	WALL-MOUNTED STROBE - IP65 - WHITE FLASH	39
48SCE020	WALL-MOUNTED SIREN AND STROBE - IP65 - WHITE FLASH	39
48CME000	6" OUTDOOR BELL 24V DC 12MA EN54	39
48CMI000	6" INDOOR BELL 24V DC 12MA EN54	39
48SAE000	ELECTRONIC SIREN, IP66 EN54	39
48FPT000	FLOOR DOOR LED INDICATOR	31-34
43PAT000	PROTECTIVE BUTTON COVER, SET OF 5 PCS	31-34
48CAC001	TEST CHAMBER FOR DUCTS	39
48SAE001	BACKPLATE FOR 48SAE000 SIREN IP66 MOUNTING	39
48FME051	50 KG DOOR HOLDER	40
48FME052	50 KG DOOR HOLDER - 15 CM WALL/FLOOR BRACKET	40
48FME053	50 KG DOOR HOLDER - 30 CM WALL/FLOOR BRACKET	40
48FME101	100 KG DOOR HOLDER	40
48FMA01	ALUMINIUM COVER FOR 48FME051	40
48FMA02	ALUMINIUM COVER FOR 48FME101	40
48FMA03	FLOOR-STANDING BACKPLATE FOR 48FME051 AND 48FME101	40
48CVI115	FIRE CABLE EN50200 CEI20-105 PH30 2X1.5 100 M	41
48CVI125	FIRE CABLE EN50200 CEI20-105 PH30 2X2.5 100M	41
48ALM000	ADDITIONAL POWER SUPPLY UNIT 2A	41
48ALM001	ADDITIONAL POWER SUPPLY UNIT 4A	41
30076003	12V DC / 7 AH LEAD BATTERY	41
30076004	12V DC / 18 AH LEAD BATTERY	41
30076005	12V DC / 27 AH LEAD BATTERY	41
30076006	12V DC / 40 AH LEAD BATTERY	41
48CCB000	METAL HOUSING FOR ADDITIONAL BATTERIES	41
48SDT001	AEROSOL FOR SMOKE DETECTOR TESTING	41
ILS-1	ASPIRATING DETECTOR, 1 ZONE, 1 DETECT.	42
ILS-2	ASPIRATING DETECTOR, 1 ZONE, 2 DETECT.	42
IFT-P	ASPIRATING SMOKE DETECTOR - 1 ZONE, 2 CHANNELS	42
PKIT-15-E	15 METER PIPE AND ACCESSORIES KIT	42
PKIT-30-E	30 METER PIPE AND ACCESSORIES KIT	42
PKIT-60-E	60 METER PIPE AND ACCESSORIES KIT	43

PIP-001	RED ABS 25 MM PIPE, 20X 3 METERS	43
PIP-002	CONNECTION SOCKET FOR 25MM PIPE (10 PCS)	43
PIP-003	SOCKET UNION FOR 25MM PIPE (10 PCS)	43
PIP-005	90 ELBOW FOR 25MM PIPE (10 PCS)	43
PIP-006	45 ELBOW FOR 25MM PIPE (10 PCS)	43
PIP-007	END CAP FOR 25MM PIPE (10 PCS)	43
PIP-008	EQUAL TEE FOR 25MM PIPE (10 PCS)	43
PIP-009	CLIP FOR 25MM PIPE (20 PCS)	43
PIP-014	PIPE CUTTERS	43
059-007	CONICAL SAMPLE POINT KIT AND 2M TUBE	43
059-001	FLUSH SAMPLE POINT KIT AND 2M PIPE	43
144-013	CONICAL SAMPLE POINT HEAD	43
PIP-015	FLUSH SAMPLE POINT HEAD FOR CAPILLARY PIPE	43
PIP-016	TEE ADAPTER FOR CAPILLARY PIPE (10 PCS)	43
PIP-027	REMOTE SAMPLING TEST POINT FOR CAPILLARY TUBE	43
PIP-026	25MM FLEXIBLE CONNECTOR, 30 CM	44
PIP-021	25MM FLEXIBLE CONNECTOR, 100 CM	44
PIP-025	WATER FILTER WITH TRANSPARENT PIPE AND VALVE	44
222-059	DISCREET END CAP FOR CAPILLARY PIPE (10 PCS)	44
221-035	RED 10MM CAPILLARY PIPE (100M)	44
221-036	CLEAR 10MM CAPILLARY PIPE (100M)	44
128-014	ROUND SAMPLING POINT LABEL (100 PCS)	44
128-046	RECTANGULAR SAMPLING POINT LABEL (100 PCS)	44
128-015	SMOKE DETECTOR PIPE LABEL (100 PCS)	44
VSP-850-R	25MM IN-LINE EXTERNAL FILTER - RED	44
VSP-855-4	REPLACEMENT FOR FILTER VSP-850-R - 4 PIECES	44
02-FL53	REPLACEMENT FILTER ELEMENT, ILS1/2 AND IFT-P 10 PCS	44
02-FL56	REPLACEMENT FILTER ELEMENT, IFT-P STAGE 2, 10 PCS	44
COLL250	ADHESIVE FOR PIPES AND SOCKETS 250ML	44
45TRS000	WIRELESS SIGNAL TRANSLATOR FOR CONVENTIONAL ZONE	45
45RPT000	WIRELESS SIGNAL REPEATER FOR RADIO SYSTEM	45
45RFU000	WIRELESS OPTICAL SMOKE DETECTOR	45
45RML000	WIRELESS MULTI-CRITERION DETECTOR	45
45RCS000	WIRELESS THERMAL DETECTOR	45
45PAM000	MANUAL WIRELESS ALARM POINT	45
45SAI020	WIRELESS WALL-MOUNTED SIREN	45
45SCI000	WIRELESS SIREN WITH FLASHING LIGHT	45
45MOD000	MODULE FOR WIRELESS SIREN	45
45SAB000	BASE WITH WIRELESS SIREN	45
45SAC000	COVER FOR BASE WITH WIRELESS SIREN	46
45FPT000	REMOTE WIRELESS SIGNALLING UNIT	46
45PAK000	SPARE KEY FOR 45PAM000	46
48BAZ000	ZENER BARRIER FOR ATEX DETECTORS	46
48BAZ001	ZENER BARRIER FOR ATEX SIREN	46
48RBX000	MOUNTING BASE FOR ATEX DETECTORS	46
48RCX000	ATEX HEAT-RATE OF RISE DETECTOR	46
48SAX000	ATEX SIREN	46
48PAX000	ATEX ALARM BUTTON	46



COMELIT: INTEGRATED SOLUTIONS

VIDEO ENTRY SYSTEMS



ACCESS CONTROL



SINGLE/TWO FAMILY RESIDENCE

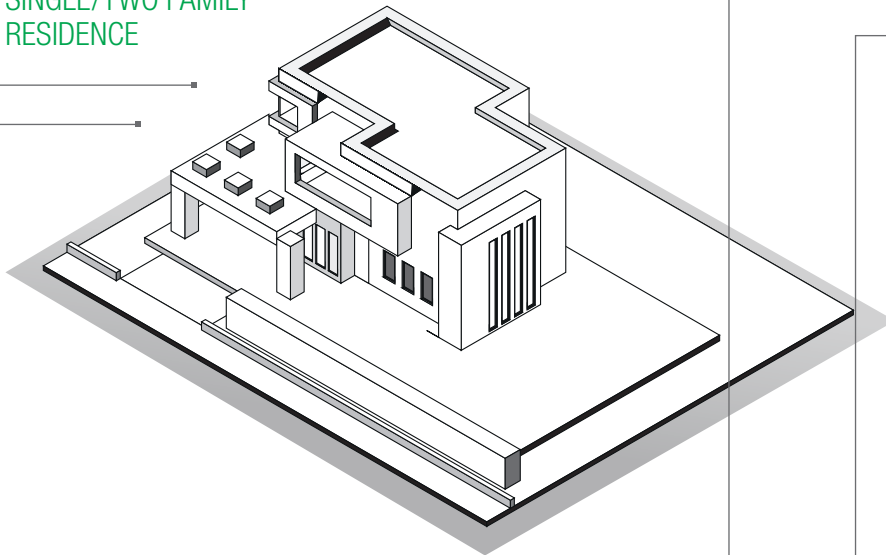

HOME AUTOMATION



LIGHTING AND RGB MANAGEMENT



OPENING AUTOMATION



CLIMATE CONTROL



SCENARIOS



ENERGY MANAGEMENT



ANTI-INTRUSION



ENERGY MANAGEMENT



IRRIGATION



DOOR ENTRY SYSTEMS



VIDEO SURVEILLANCE



AUDIO DISTRIBUTION

VIDEO SURVEILLANCE



VIDEO ENTRY SYSTEMS



LARGE
RESIDENTIAL/COMMERCIAL
COMPLEX

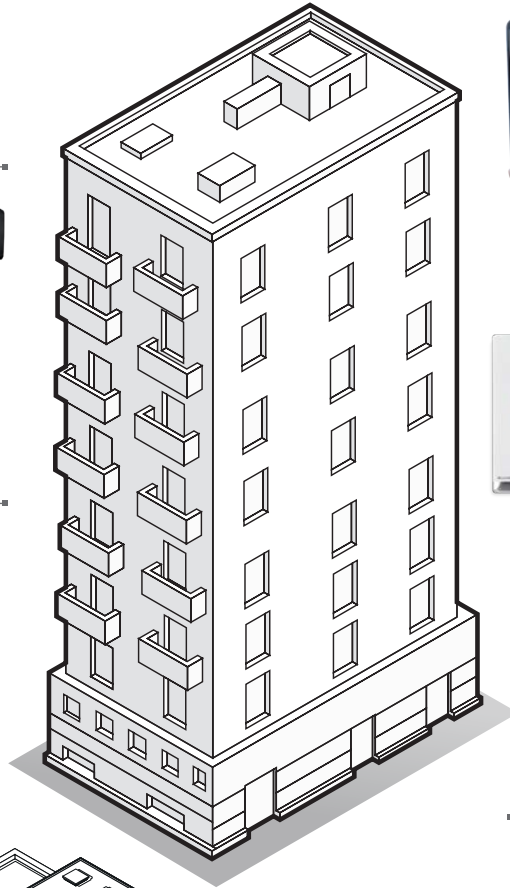

INDUSTRIAL FACILITY

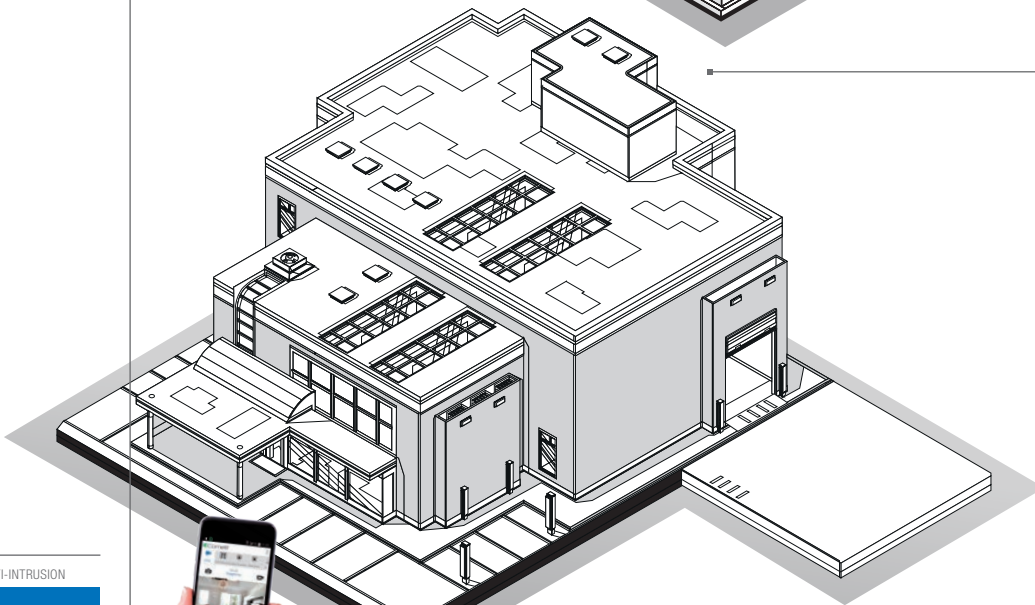

ANTI-INTRUSION



FIRE DETECTION



- [IT] **Comelit Group Spa**
Via Don Arrigoni 5
24020 Rovetta S. Lorenzo
Bergamo Italy
Tel. +39 (0) 346 750011
Fax +39 (0) 346 71436
www.comelitgroup.com
info@comelit.it
- [AU] **Comelit Australia Pty Ltd**
Unit 6/11 Sabre Drive
Port Melbourne
Victoria 3207
Ph. 1300 889000
enquiries@comelitgroup.com.au
- [BE] **Comelit Group Belgium**
Kleinewinkellan 24
1853 Grimbergen
Belgium
Tel. +32 2 411 50 99
Fax. +32 2 411 50 97
www.comelit.be
info@comelit.be
- [CO] **Comelit Colombia**
Carrera 76#73-44, 2° piso
Bogotá, Colombia
Tel. (57-1) 4929358/79686
james.quimbaya@comelit.it
www.comelit.com.co
- [DE] **Comelit Group S.p.A.
Deutschland**
Konrad-Zuse-Str. 2
41516 Grevenbroich
Deutschland
Tel. 0 21 82-82 96-0
Fax: 0 21 82-82 96-299
www.comelit.de
info@comelit.de
- [ES] **Comelit Group Spa
Sucursal en Espana**
Calle Pintor Roig i Soler, 28
08916 - Badalona (Barcelona)
Tel. +34 932 430 376
Fax +34 934 084 683
www.comelit.es
info@comelit.es
- [FR] **Comelit Immotec**
18, rue Séjourné
94000 CRETEIL CEDEX
Tél. +33 (0) 1 43 53 97 97
Fax +33 (0) 1 43 53 97 87
www.comelit.fr
contact@comelit-immotec.fr
- [GR] **Comelit Hellas - Telergo
Security Ltd**
Roumelis, 59
16451 Argyroupoli - Athens
Tel. +30 210 99 68 605-6
Fax +30 210 99 45 560
www.comelit.gr
telergo@otenet.gr
- [IE] **Comelit Ireland**
Ground Floor
14 Herbert Street - Dublin 2
Tel. +353 (0) 1 619 0204
Fax +353 (0) 1 619 0298
www.comelit.ie
info@comelit.ie
- [NL] **Comelit Nederland BV**
Buitendijks 1-3356 LX
Papendrecht
Tel. +31 786511201
Fax +31 786170955
www.comelit.nl
info@comelit.nl
- [SG] **Comelit South East Asia**
Victory Centre
110 Lorong 23 Geylang, #05-10
388410 Singapore
Tel. +6567024780
www.comelit.sg
office@comelit.sg
- [AE] **Comelit Middle East**
Office 1-154, Techno Hub
Dubai Silicon Oasis
Free zone - Dubai, UAE
www.comelit.ae
info@comelit.ae
- [GB] **Comelit Group UK Ltd**
Unit 4 Mallow Park Watchmead
Welwyn Garden City Herts
AL7 1GX
Tel: +44 (0)1707377203
Fax: +44 (0)1707377204
www.comelitgroup.co.uk
info@comelitgroup.co.uk
- [US] **Comelit Usa**
2021 S. Myrtle Avenue
Monrovia, CA 91016
Tel. +1 626 930 0388
Fax +1 626 930 0488
www.comelitusa.com
sales@comelitusa.com
- [RU] **Comelit Group Russia**
Moscow,
Krasnogvardeisliy bulvar, 7A
tel: +7(495)789-49-33
www.comelit.ru
mail: tsn@comelit.ru
mail: info@comelit.ru
- [HK] **Comelit Hong Kong**
Representative Office
Rm 601, 6/F, Tung Hip
Commercial Building,
248 Dex Voeux Road Central,
Hong Kong
Office direct line:
+852 3582 1632
www.comelit.hk
info@comelit.hk

Comelit Group Spa

Via Don Arrigoni 5
24020 Rovetta S. Lorenzo
Bergamo [Italy]
Tel. +39 (0) 346 750011
Fax +39 (0) 34671436
www.comelitgroup.com

 **Comelit**[®]
Passion. Technology. Design.

8 023903 363487

cod. 2GG1000512