

Mechanical and Electrical Safe Systems of Work and Technical Compliance

Training Prospectus | Version 23.1



A Leading UK and International Training Provider



50,000ft²
of Training Facilities



30
Classrooms



80+
Courses



Knowledgeable
and Experienced Training Staff



Introduction from

Gary Cooper

(MIHEEM Tech IOSH MSOE MIPlantE)
Managing Director

We are an industry-leading UK and international provider of Safe Systems of Work, technical and compliance training.

We have an extensive portfolio of over 80 City & Guilds and BPEC accredited courses.

The Safe Systems of Work (SSoW) courses that we deliver are based upon the high risk disciplines within facilities management, Ministry of Defence (MOD) and healthcare environments.

It is industry standard that companies responsible for high risk engineering systems, adopt their own safety rules and procedures that their teams adhere to. These rules, and their respective requirements, are the foundation of our course portfolio.



Our courses are delivered by our highly experienced training team which allows us to develop our own in-house courses tailored for those within the relevant industries.

Training is in-line with the latest legislation and guidelines so that your team will receive up-to-date, factual tuition.

G.Cooper

How we Deliver our Training

In-centre, at your site and online

We cover the whole of the UK from our purpose built, well established training centres in York, Slough and Livingston. Fitted with industry leading practical training facilities, this ensures that your team receive the best training possible.

Alternatively we are also able to provide training directly to your site or online through our remote training courses.



APPROVED
CENTRE

Accommodation Required?

We can arrange **accommodation from £105^{+VAT}** per person per night. Price includes dinner, bed and breakfast.

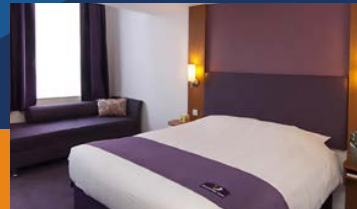

Our Training Facilities

York



Slough



Tudor Court



Bedford Avenue



Buckingham Avenue

York:

Unit 5, 6, and 8 Opus Avenue
Unit 4 Tudor Court

Slough:

468 Malton Avenue
180 Bedford Avenue
103 Buckingham Avenue

Livingston:

5 Deer Park Avenue

Deer Park Avenue



Our Training Courses

Mechanical and Electrical Safe Systems of Work and Technical Compliance

Management of Safe Systems

Authorising Engineer	10
Facilities Management Contract Managers Technical Awareness	12

High Voltage

Authorised Person High Voltage - Operation and Safety	22
Authorised Person High Voltage - HTM 06-03	23
AP/SAP High Voltage - MOD Sectors	24
SAP High Voltage - Commercial and Industrial Sectors	25
High Voltage Maintenance	26
High Voltage Awareness	27
High Voltage Technical	28
Substation Entry Awareness	29

Low Voltage

Authorised Person Electrical Low Voltage	32
Skilled/Competent Person Electrical Low Voltage	33
Authorised Person Electrical Low Voltage HTM 06-02	34
Competent Person Electrical Low Voltage HTM 06-02	35
Authorised Person Electrical Low Voltage HTM 06-02 Refresher	36
Standby Systems	37





Hazardous areas

Authorised Person MOD Hazardous Areas	40
---------------------------------------	----

Airfield Lighting

Aeronautical Ground Lighting Technician	44
Authorised Person Aeronautical Ground Lighting	45
Aeronautical Ground Lighting Maintenance (Systems Management)	46
Authorised Person Aeronautical Ground Lighting (MOD)	47
Heliports Visual Aids Principles	48
Helicopter Landing Areas for Hospitals	49

Mechanical and Pressure Systems

Authorised Person Mechanical and Pressure Systems	52
Skilled Person Mechanical and Pressure Systems	53

Confined Spaces and Working At Height

Authorised Person Confined Spaces (Commercial)	56
Authorised Person Confined Spaces (MOD)	57
Authorised Person Confined Spaces Refresher	58
Competent Person Confined Spaces	59
Competent Person Confined Spaces Refresher	60
Authorised Person Working At Height (MOD)	62
Authorised Person Working At Height (Commercial)	63

Petroleum

Authorised Person Petroleum	66
Authorised Person Petroleum Refresher	67



Medical Gas Pipeline Systems HTM 02-01

Authorised Person Medical Gas Pipeline Systems HTM 02-01	74
Authorised Person Medical Gas Pipeline Systems Refresher HTM 02-01	75
Competent Person Medical Gas Pipeline Systems HTM 02-01	76
Competent Person Medical Gas Pipeline Systems Refresher HTM 02-01	77
Dental Compressed Air and Vacuum Systems for use in Healthcare	78

Ventilation HTM 03-01

Authorised Person Ventilation HTM 03-01	82
Authorised Person Ventilation Refresher HTM 03-01	83
Competent Person Ventilation HTM 03-01	84
Validation and Verification of Healthcare Ventilation Systems HTM 03-01	85

Electrical Installations

18th Edition Wiring Regulations City & Guilds 2382-22	88
Inspection, Testing and Certification of Electrical Installations City & Guilds 2391-52	89
In-Service Inspection and Testing of Electrical Equipment (PAT Testing) City & Guilds 2377-77	90
Fundamental Inspection and Electrical Testing City & Guilds 2392-10	92
Design and Verification of Electrical Installations City & Guilds 2396	93
Electric Vehicle Charging Equipment Installation City & Guilds 2919-01	94
18th Edition Wiring Regulations Amendment 2 – Update	95





Mechanical and Electrical Conversion

Electrical to Mechanical Conversion	98
Mechanical to Electrical Conversion	99

F-Gas Handling

F-Gas (Category 1) City & Guilds 2079-11	102
F-Gas (Category 2) City & Guilds 2079-12	103
F-Gas (Category 3) City & Guilds 2079-13	104
F-Gas (Category 4) City & Guilds 2079-14	105
Hydrocarbon Qualification City & Guilds 6187-21	106
F-Gas Compliance	108
Introduction to Air Conditioning	109

Fire Safety

Fire Safety Responsible Person Introduction	118
Fire Safety Responsible Person Introduction - Healthcare Premises	119
Fire Door Survey and Inspection	120
Fire and Smoke Damper Survey and Inspection	121
Fire Stopping Survey and Inspection	122
Fire Safety Technical Awareness	123
Escape Lighting	124
Fire Alarms and Detection Systems - Commercial	125
Fire Alarms and Detection Systems - Domestic	126

ALSTOM

BIENVOENIDOS

ALSTOM



Management of Safe Systems



Course Name	Code	Length	Price Exc. VAT
Authorising Engineer	AUENG	2 Day	£625
Facilities Management Contract Managers Technical Awareness	FMTA	2 Day	£525

Training available in York, Slough, Livingston and On-site



★★★★★

"Another Fantastic Course"

"Excellent course - first class instructors - superb facilities"

Jason - Beattie Flanigan

City & Guilds Accredited
Authorising Engineer

Authorising Engineer

📍 York, Slough, Livingston and On-site | 2 Day | £625

Course Overview:

This course will provide you with the background knowledge required to carry out Authorising Engineer (AE) duties in support of statutory health and safety compliance. Our course can also be used to help you demonstrate the competency requirements of mandatory standards (MOD's JSP 375 Volume 3), guidance documents (Healthcare Technical Memoranda) or company rules.

Please note we have the ability to offer this course on-site at your premises.

Who Is This Course For:

This course has been designed for experienced engineering staff responsible for the implementation, administration, monitoring and management of Safe Systems of Work, and who are looking to be appointed as an Authorising Engineer. The course will cover the key roles of an Authorising Engineer such as the appointment of operational staff - who will implement and work with the defined Safe Systems of Work.

Key Learning Areas Covered In This Course:

- Understand the management of Safe Systems of Work
- Compliance and the role of the Authorising Engineer
- Authorised person selection, training and appointment
- Safety documentation - setting and maintaining standards
- Auditing and monitoring
- Incident investigation
- Maintaining competence
- Completion of log books and associated documentation



The Role Of An Authorising Engineer:

The Authorising Engineer acts as an independent adviser to an organisation.

The AE should be appointed by the organisation to provide services in accordance with the organisation's relevant Safe Systems of Work, as well as HSE, Health Technical Memoranda (HTM) or Joint Service Publication (JSP) guidance.

The AE's role is to act as a technical assessor who makes recommendations for the appointment of Authorised Persons (AP's). Once AP's are appointed, the AE will continue to monitor the performance of the service and provide annual audits. With regards to audit in particular, the AE should remain independent of the operational structure of the organisation.



"A Great Service"

"A great service delivered by a very knowledgeable team in a good location with outstanding facilities. Well done PPL."

Delegate Review - MOD

City & Guilds Accredited
Authorising Engineer



Facilities Management Contract Managers Technical Awareness

FMTA

📍 York, Slough, Livingston and On-site | 2 Day | **£525**

Course Overview:

This in-depth City & Guilds accredited training course has been designed to provide an overview and understanding of the statutory and regulatory inspections/maintenance tasks required within a Facilities Management contract, as detailed within CIBSE guidance. This will also cover management responsibilities, in line with Health and Safety legislation.

Who Is This Course For:

This course is for Contract Managers, within the Facilities Management environment, who require a better understanding of their engineering responsibilities, when managing contracts. This will also cover the requirement for statutory and regulatory inspections/maintenance.

The course covers a wide range of core areas including the following requirements; building services systems, fire safety, electrical systems safety, energy and environment, mechanical systems safety and ventilation systems.



**"Very well taught course -
Would definitely recommend"**

"In depth training provided by a very knowledgeable trainer. I would definitely re-use PPL for future training courses and would recommend to others considering using PPL as a training provider."

Delegate Review - NHS

City & Guilds Accredited
Facilities Management
Contract Managers
Technical Awareness



Key Learning Areas Covered In This Course:

- General H&S and the responsibility of the Contract Manager
- HSAW Act 1974 & surrounding legislation, including Contract Manager responsibilities
- Building services systems
- The requirements of the Asbestos at Work Regs, Noise at Work Regs, CoSHH, Water Systems and generic hazards in the workplace
- Fire safety requirements
- Fire Safety Order 2005 and the requirements of the Fire Risk Assessment
- Energy and environmental requirements
- Understand the variety of requirements with respects to energy and environment in a typical contract - i.e. water use, waste management, WEEE etc
- Electrical systems safety requirements
- The basic requirements of the Electricity at Work Regulations 1989
- NICEIC considerations - minor works certs, contractor control, quality supervision
- Inspection and testing requirements, PAT requirements, emergency lighting/lightning conductors
- Mechanical systems safety requirements
- The basic requirements of PSSR, PUWER, PER etc | Types of pressure systems
- Written Scheme of Examination and inspection regimes | gas safety (U&I) regs | vent systems
- Lifts, escalators and hoists
- The basic requirements of LOLER, PUWER Etc | servicing and inspection regimes for all equipment

circuits board

TO LOCAL TRANSFORMER

on

on

RING TO ISS

switch 1

switch 2

RING

main

circuit earth

MERLIN GERIN
Administrateur - RNDC

Modèle	1250	1250	1250
Niveau	100	100	100
Modèle	1250	1250	1250
Niveau	100	100	100
Modèle	1250	1250	1250
Niveau	100	100	100
Modèle	1250	1250	1250
Niveau	100	100	100
Modèle	1250	1250	1250
Niveau	100	100	100
Modèle	1250	1250	1250
Niveau	100	100	100
Modèle	1250	1250	1250
Niveau	100	100	100
Modèle	1250	1250	1250
Niveau	100	100	100
Modèle	1250	1250	1250
Niveau	100	100	100
Modèle	1250	1250	1250
Niveau	100	100	100
Modèle	1250	1250	1250
Niveau	100	100	100
Modèle	1250	1250	1250
Niveau	100	100	100
Modèle	1250	1250	1250
Niveau	100	100	100

Ratings

Modèle	1250	1250	1250
Niveau	100	100	100
Modèle	1250	1250	1250
Niveau	100	100	100
Modèle	1250	1250	1250
Niveau	100	100	100
Modèle	1250	1250	1250
Niveau	100	100	100
Modèle	1250	1250	1250
Niveau	100	100	100



High Voltage



Course Name	Code	Length	Price Exc. VAT
Authorised Person High Voltage - Operation and Safety	APHV1	5 Day	£1,385
Authorised Person High Voltage - HTM 06-03	APHV2	5 Day	£1,385
AP/SAP High Voltage - MOD Sectors	APHV3	5 Day	£1,385
SAP High Voltage - Commercial and Industrial Sectors	APHV4	5 Day	£1,385
High Voltage Maintenance	HVM	5 Day	£1,385
High Voltage Awareness	HVASM	2 Day	£525
High Voltage Technical	HVTA	3 Day	£895
Substation Entry Awareness	SUBE	1 Day	£295

Training available in York, Slough, Livingston and On-site

HIGH VOLTAGE TRAINING GUIDE

Authorised Person High Voltage Courses

Prospective Role	Typical Duties	Suggested Course(s)
Authorised Person	Responsible for the control, operation and/or maintenance of installed HV systems within all sectors. Appointed or about to be appointed as an Authorised Person.	APHV1 (page 22)
Senior Authorised Person	Responsible for control, operation and/or maintenance of installed HV systems. Appointed as Senior Authorised Person.	APHV1 (page 22) +/- APHV3 (page 24) or APHV4 (page 25)
Authorised Person (Healthcare)	Responsible for the control, operation and/or maintenance of installed HV systems. Appointed as Authorised Person in the healthcare sector.	APHV1 (page 22) +/- APHV2 (page 23)

Other High Voltage Courses

Role	Typical Duties	Optional Course(s)
Site Manager, Prospective AP, Low Voltage AP, Project Manager with an increased awareness	Responsible for the overall operation of a site or facility containing HV switchgear and the associated Health & Safety procedures for HV staff.	HVASM (page 27)
High Voltage AP, CP/SKP with an increased awareness and knowledge	Responsible for the safe operation and/or maintenance of HV switchgear.	HVM (page 26)
High voltage engineer with an increased knowledge	Responsible for the control, operation and/or maintenance of installed HV systems within any sector, which may include AP's, CP's, Skilled Persons or Operational Engineers.	HVTA (page 28)

LOW VOLTAGE TRAINING GUIDE

Authorised/Competent Person Low Voltage Courses		
Prospective Role	Typical Duties	Suitable Course(s)
Authorised Person	Responsible for the practical implementation of the LV safety procedures within the commercial sector and/or the DIO.	APLV (page 32)
Skilled Person	Responsible for the safe operation and/or maintenance of LV systems within the commercial sector and/or the DIO.	CPLV (page 33)
Authorised Person (Healthcare)	Responsible for the practical implementation of the LV safety procedures as described in HTM 06-02.	APLVH (page 34) APLVR (page 36)
Competent Person (Healthcare)	Responsible for the safe operation and/or maintenance of LV systems within healthcare environments.	CPLVH (page 35)

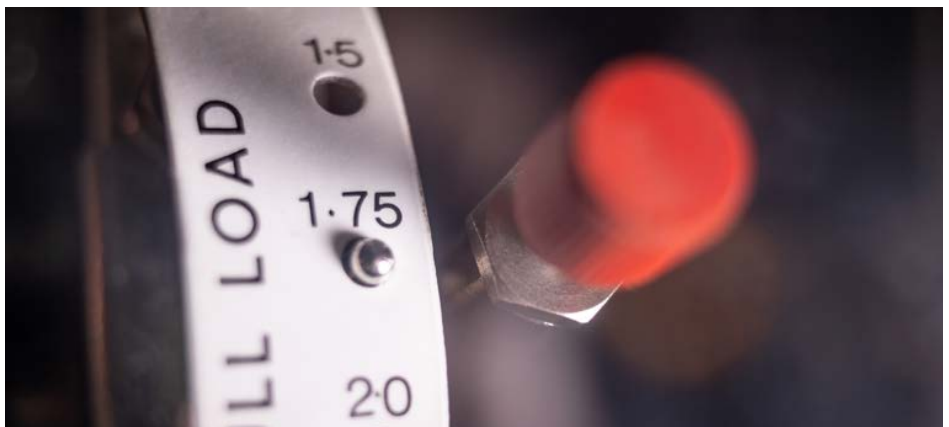

PPL HIGH VOLTAGE RING YORK

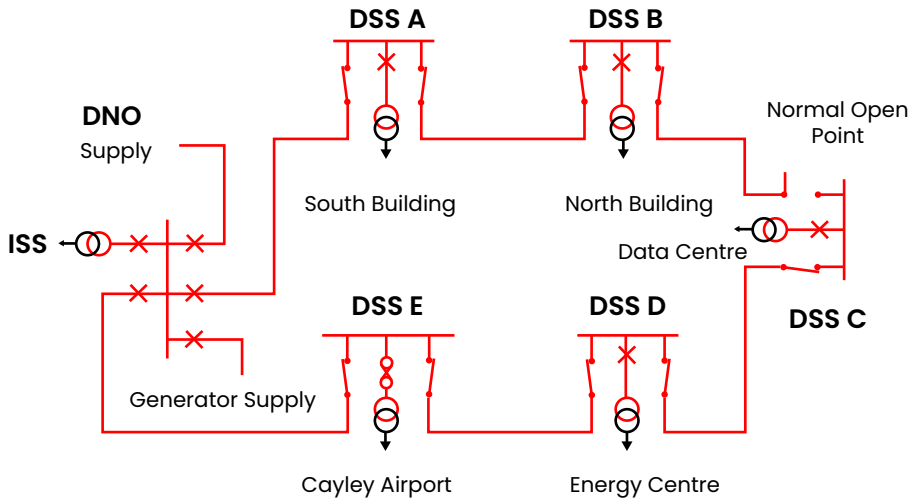

ISS
NEI Reyrrolle YMV2 VCB's



DSS A
Yorkshire Switchgear
Ringmaster SF6



DSS B
GEC Alstom Saturn SF6



DSS C
Lucy Sabre VRN2a SF6



DSS D
Merlin Gerin
Ringmaster SF6



DSS E
Lucy FRMU
MK1 Oil



DSS G
Merlin Gerin
Genie



Live Phasing
Demonstration Rig
2 x Reyrrolle LMT23 OCB

PPL NORTH HIGH VOLTAGE RING YORK

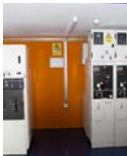
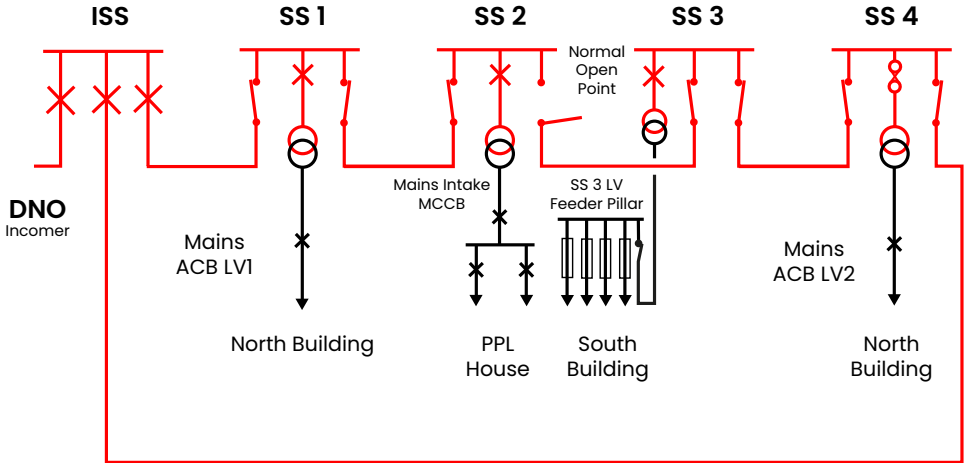

ISS
Merlin Gerin
Genie EVO, 2
x Merlin Gerin
Genie CB6
Circuit Breaker



SS 1
Schneider
RN2C SF6 RMU



SS 2
Lucy Sabre
VRN2a SF6



SS 3
2 x Merlin Gerin
SE6 SF6
Switches & Circuit
Breaker



SS 4
Lucy FRMU MK2a
Oil Filled
RMU



**Air Circuit
Breaker**
ABB SACE Emax 2



Transformer
Parson Peebles
Transformer



Panel Board
Merlin Gerin
MCCB



LV Feeder Pillar
Merlin Gerin
1600A LV
Feeder Pillar



Merlin Gerin
Masterpact

PPL WINDSOR NORTH RING

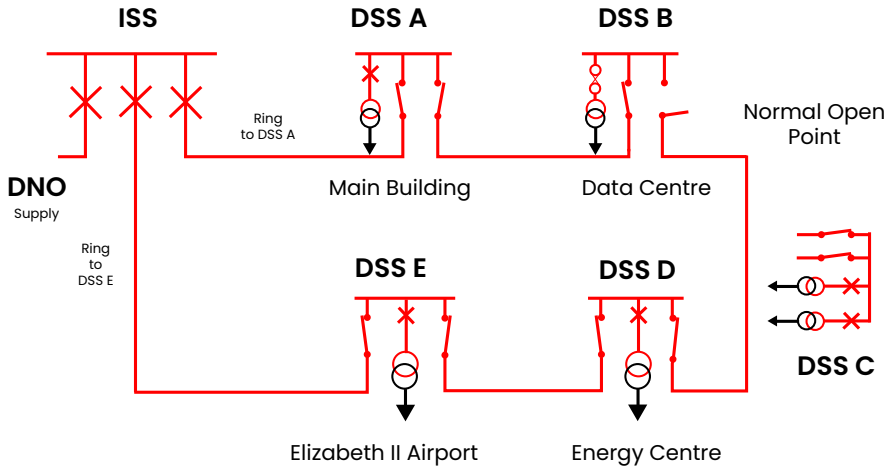

ISS
GEC Alstom HWXA VCB's



DSS A
Merlin Gerin Ringmaster
CE2 200A SF6 CB SE6 630A SF6
Switches



DSS B
Long & Crawford T4GF3
Oil RMU



DSS C
Eaton XIRIA



DSS D
Hawker Siddeley Brush
Falcon SF6 RMU



DSS E
Merlin Gerin Ringmaster
RN2C SF6 RMU



DSS G
Packaged Substation
Merlin Gerin SE6 630A Switch +
Transformer Earth Switch



Stand Alone
Genie Evo

PPL WINDSOR NORTH RING NO. 2

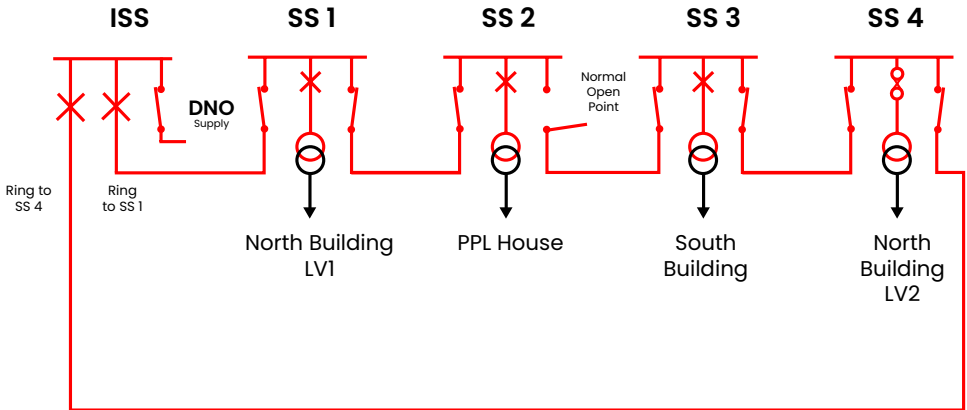

ISS
Reyrolle LMT 23T OCB's
Reyrolle oil switch
(incomer)



SS 1
Merlin Gerin Ringmaster
RN2c SF6 RMU



SS 2
Lucy Sabre
VRN2a SF6 RMU



SS 3
Alstom RT
'Saturn' SF6
RMU



SS 4
Lucy Mk1a FRMU OIL RMU



Authorised Person High Voltage – Operation and Safety

📍 York, Slough and On-site | 5 Day | **£1,385**

Course Overview:

This City & Guilds Accredited course will enable you to gain the knowledge required to carry out Authorised Person duties and responsibilities in order to achieve compliance with the requirements of the Electricity at Work Regulations 1989 and implement mandatory standards or company safety rules.

Please note we have the ability to offer this course on-site at your premises and on a bespoke basis.

Who Is This Course For:

This course is aimed at experienced engineering staff with responsibility for the control, operation or maintenance of installed high voltage systems and who may be appointed as Authorised Person (Electrical High Voltage). This course may also be used as an Authorised Person refresher course for the commercial sector. For those working to the HTM structure, you will require the Authorised Person High Voltage – HTM 06-03 course. For those working to JSP 375 Vol 3, you will require the Authorised Person High Voltage MOD Sectors course.

Key Learning Areas Covered In This Course:

- Introduction to high voltage distribution systems
- High voltage switchgear types and operation
- Substation equipment
- Low voltage distribution systems
- Requirements for safe operation of high voltage systems
- Roles and duties of the Authorised Person
- Safe working procedures, HSG 85 or company safety rules
- Completion of safety documentation
- Operation and isolation of high voltage systems
- Introduction to protection systems
- Maintenance procedures regarding high voltage assets

Authorised Person High Voltage - HTM 06-03

📍 York, Slough and On-site | 5 Day | **£1,385**

APHV2

Course Overview:

This City & Guilds accredited course will enable you to gain the additional knowledge required to carry out Authorised Person duties and responsibilities in order to achieve compliance with the requirements of the Electricity at Work Regulations 1989 and the specific requirements of Health Technical Memorandum 06-03 Electrical Safety Guidance for High Voltage Systems.

Please note we have the ability to offer this course on-site at your premises and on a bespoke basis.

Who Is This Course For:

This course is aimed at experienced engineering staff with responsibility for the control, operation or maintenance of installed high voltage systems and who may be appointed as Authorised Person (Electrical High Voltage). It is recommended that delegates have previously either attended the High Voltage Operation and Safety course, a recognised industry equivalent, or are currently appointed as APs. This healthcare specific authorised person course, can follow our High Voltage Operation and Safety course, providing HV beginners with the required 10 days of training, as specified in HTM 06-03.

Key Learning Areas Covered In This Course:

- Electricity at Work Regulations
- Requirements for safe operation under HTM 06-03
- High voltage distribution systems
- High voltage equipment including switchgear and protective devices
- Safe isolation of standby power supplies and equipment
- Roles and duties of the Authorised Person
- Completion of safety documents



AP/SAP High Voltage – MOD Sectors

📍 York, Slough and On-site | 5 Day | **£1,385**

Course Overview:

This City & Guilds accredited course will enable you to gain the additional knowledge required to carry out Authorised Person/Senior Authorised Person duties and responsibilities in order to achieve compliance with the requirements of the Electricity at Work Regulations 1989 and implement mandatory standards, JSP 375 Vol 3.

Please note we have the ability to offer this course on-site at your premises and on a bespoke basis.

Who Is This Course For:

This course is aimed at experienced engineering staff with responsibility for the control, operation or maintenance of installed high voltage systems and who may be appointed as Senior/Authorised Person (Electrical High Voltage). It is also suitable as the 2nd week of the 2-week beginner course, following the High Voltage Operation and Safety course.

Key Learning Areas Covered In This Course:

- Requirements for safe operation of high voltage systems
- High voltage distribution switchgear and equipment
- High and Low voltage distribution systems
- High voltage working and operation
- Safe isolation around standby power supplies and equipment
- Roles and duties of the Authorised Person/Senior Authorised Person
- Practical implementation of Safe Systems to establish safety rules
- Completion of safety documents through practical exercises
- High Voltage protection
- Electricity at Work Regulations 1989 and the published guidance available

SAP High Voltage – Commercial and Industrial Sectors

📍 York and Slough | 5 Day | **£1,385**

Course Overview:

This City & Guilds accredited course will enable you to gain the additional knowledge required to carry out Senior Authorised Person duties and responsibilities in order to achieve compliance with the requirements of the Electricity at Work 1989 and implement mandatory standards, such as company electrical safety rules. From attending this course you will gain a greater understanding of the role of the SAP.

Please note: prospective delegates must have been appointed as an Authorised Person (High Voltage) within the last 5 years, OR be currently serving as a Senior Authorised Person (High Voltage). Proof will be required to attend the course.

Who Is This Course For:

This course is aimed at experienced HVAPs in the industrial and commercial sectors with the responsibility for the control, operation or maintenance of installed high voltage systems and who may be appointed as Senior Authorised Person (Electrical High Voltage). It is also suitable for existing High Voltage Authorised Persons looking for a HVSAP refresher. This course would be only suitable for those who are already appointed as APs or those who have recently completed the High Voltage Operation and Safety course

Key Learning Areas Covered In This Course:

- Requirements for safe operation of high voltage systems
- Fault finding
- High voltage distribution switchgear and equipment
- High and Low voltage distribution systems
- High voltage working and operation
- Safe isolation around standby power supplies and equipment
- Roles and duties of the safety team, Appointments and Assessments
- Practical implementation of Safe Systems to establish safety rules
- Completion of safety documents through practical exercises
- High Voltage protection and Distribution Transformers
- Electricity at Work Safety Regulations 1989 and the published guidance available

Accommodation available from **£105 +VAT** per night (including DBB)



City & Guilds
ACCREDITED

High Voltage Maintenance

📍 York and Slough | 5 Day | **£1,385**

Course Overview:

This City & Guilds accredited course will enable you to gain the additional knowledge required to carry out inspection and maintenance of high voltage switchgear and associated systems.

Throughout this course receive hands-on practical training, led by our highly experienced training team, with practical sessions including; OCB maintenance, Fault finding, High voltage pressure testing, Secondary Injection testing for protection devices, Thermal Imaging, Partial Discharge Testing, Cable Location and Identification and Time Domain Reflectometry.

Who Is This Course For:

This course is aimed at experienced staff such as managers and supervisors who have responsibility for the safety and maintenance of high voltage switchgear. It is particularly suitable for the High Voltage Competent Person and those who may be required to undertake inspection, maintenance and testing of high voltage equipment.

Key Learning Areas Covered In This Course:

- Electricity at Work Regulations requirements for maintenance
- Recommendations for keeping electrical switchgear safe in accordance with HSG 230
- High voltage equipment including switchgear and protective devices
- Care and maintenance requirements for oil and non-oil circuit breakers
- Testing of earthing systems
- Maintenance of ancillary equipment
- Condition monitoring techniques
- Post maintenance checks including pressure testing
- Safe working procedures
- Practical exercises on high voltage assets

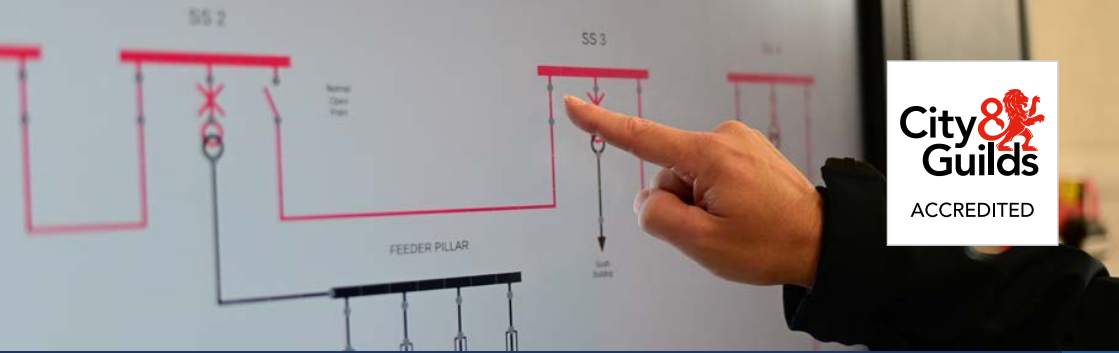

High Voltage Awareness

📍 York, Slough and On-site | 2 Day | **£525**

Course Overview:

This City & Guilds accredited course will enable you to gain an understanding of high voltage systems, equipment and the safe systems of work involved in their control and operation.

Who Is This Course For:

This course has been designed for engineers who wish to gain an understanding of high voltage systems as well as for management with the responsibility for overseeing sites that contain high voltage electrical equipment.

This is an ideal pilot course for those considering High Voltage Authorised Person courses.

Key Learning Areas Covered In This Course:

- Introduction to high voltage distribution systems
- High voltage switchgear types and operation
- Substation equipment
- Low voltage distribution systems
- Requirements for safe operation of high voltage systems
- Roles and duties of the Authorised Person
- Safe working procedures, HSG 85 or JSP 375 Volume 3 or company safety rules
- Completion of safety documentation
- Operation and isolation of high voltage systems
- Introduction to protection systems
- Maintenance procedures regarding high voltage assets

High Voltage Technical

📍 York | 3 Day | £895

Course Overview:

This course will provide you with the practical and theoretical awareness of the more technical aspects and use of high voltage systems and equipment. The aim of this course is to consolidate and enhance current knowledge and explore common engineering techniques.

Who Is This Course For:

This course is aimed at engineering staff who work within high voltage environments, as either an Authorised Person, Competent Person or engineers within this discipline.

Key Learning Areas Covered In This Course:

- Cables and testing
- Protection - schemes and methods
- Transformers - theory, selection and maintenance
- Earthing principles and testing
- Maintenance techniques
- Switchgear operation and testing



Substation Entry Awareness

📍 York and Slough | 1 Day | £295

Course Overview:

Access requirements for work such as painting, checking emergency lighting and servicing fire extinguishers, or escorting contractors such as gardening, pest control or cleaning all require an awareness of the environment and potential hazards inside substations. This City & Guilds accredited course looks at the dangers of electricity and hazards that could be encountered, what behaviour and control measures are required when entering these areas, the role of personnel and the type of documentation which could be used to gain access.

Who Is This Course For:

Staff who may occasionally or regularly enter substations to do work (other than high voltage work) or to accompany an Authorised Person while high voltage working or testing is being carried out.

This course is suitable for those that need to understand the access requirements for work such as painting, checking emergency lighting and servicing fire extinguishers, or escorting contractors such as gardening, pest control or cleaning.

Key Learning Areas Covered In This Course:

- Dangers of electricity
- Legislation
- Electricity at Work Regulations
- Roles and duties
- Documentation
- Switchgear and hazards
- Substation layouts and equipment
- Walk round a substation
- Risk assessments



10.4 3.8 A

DORMAN SMITH

DORMAN SMITH Airbreak

SOLID STATE
1-12-13-14

0

2

0

1

4

4

4

ADD CONTACTS LTD
FOR SUPPLY OF THE AIR
TEL: 01753 530000
FAX: 01753 530010

AB4PB12500
10 x 1200A
100 x 600V

100 x 600V

MAIN SUPPLY
ACROSSING AIR



50V

Low Voltage



Course Name	Code	Length	Price Exc. VAT
Authorised Person Electrical Low Voltage	APLV	4 Day	£1,195
Skilled/Competent Person Electrical Low Voltage	CPLV	2 Day	£525
Authorised Person Electrical Low Voltage HTM 06-02	APLVH	5 Day	£1,385
Competent Person Electrical Low Voltage HTM 06-02	CPLVH	2 Day	£525
Authorised Person Electrical Low Voltage HTM 06-02 Refresher	APLVR	3 Day	£895
Standby Systems	STBS	3 Day	£895

Training available in York, Slough, Livingston and On-site



"Great training experience."

"Friendly & relaxing environment, lots to look at in the workshop and to be shown what each element does inline with the course."

Adam - Emcor UK

City & Guilds Accredited
Authorised Person Electrical
Low Voltage HTM 06-02
Refresher



Authorised Person Electrical Low Voltage

📍 York, Slough, Livingston and On-site | 4 Day | **£1,195**

Course Overview:

The City & Guilds accredited Authorised Person Electrical Low Voltage course will enable you to gain the knowledge required to carry out Authorised Person duties and responsibilities in order to achieve compliance with the requirements of the Electricity at Work Regulations 1989, using JSP375 as the reference for safe procedures.

Please note we have the ability to offer this course on-site at client premises and on a bespoke basis.

Who Is This Course For:

This course is aimed at experienced engineering staff within the MOD and Commercial sectors who may have responsibility for the control, operation or maintenance of installed low voltage systems and who may be appointed as Authorised Person (Electrical Low Voltage).

Key Learning Areas Covered In This Course:

- Low voltage equipment including switchgear and protective devices
- Requirements of Electricity at Work Regulations
- Safe working practices with electricity (HSG85+JSP375)
- Safe isolation of standby power supplies and UPS equipment
- Roles and duties of personnel
- Low voltage working procedures
- Audit requirements
- Practical exercises in completion of safety documentation and hands on implementation
- Completion of log books and associated documentation



Skilled/Competent Person Electrical Low Voltage

📍 York, Slough and Livingston | 2 Day | **£525^{+VAT}**

GPLV

Course Overview:

This City & Guilds accredited course will enable you to gain the knowledge required to carry out the role of Skilled/Competent Person (Electrical). It can also assist in demonstrating competence during the formal appointment process.

Please note we have the ability to offer this course on-site at client premises and on a bespoke basis.

Who Is This Course For:

This course is aimed at electrical staff with responsibility for the operation or maintenance of installed low voltage systems and who may be nominated as a Competent/Skilled Person.

Key Learning Areas Covered In This Course:

- Technical overview of electrical systems and protection concepts
- Awareness of electrical dangers
- Requirements of Electricity at Work Regulations
- Safe working practices with electricity
- Low voltage working procedures
- Receipt of safety documentation
- Practical exercises in isolation of low voltage equipment

Authorised Person Electrical Low Voltage HTM 06-02

📍 York, Slough, Livingston and On-site | 5 Day | **£1,385**^{***VAT}

Course Overview:

This City & Guilds accredited course will enable you to gain the knowledge required to carry out Authorised Person duties and responsibilities in order to achieve compliance with the requirements of the Electricity at Work Regulations 1989. The course is based on the specific requirements of Health Technical Memorandum HTM 06-02 Electrical Safety Guidance for Low Voltage Systems.

Please note we have the ability to offer this course on-site at client premises and on a bespoke basis.

Who Is This Course For:

This course is aimed at experienced engineering staff with the responsibility for the control, operation or maintenance of installed low voltage systems within healthcare environments and also those who may be appointed as Authorised Person (Electrical Low Voltage).

Key Learning Areas Covered In This Course:

- Requirements of Electricity at Work Regulations
- Working procedures to HTM 06-02
- Low voltage equipment including switchgear and protective devices
- Appointment and auditing procedures
- Requirements of BS7671 with regards to Health Technical Memorandum (HTM)
- Roles and duties of personnel
- Safe isolation of standby power supplies and equipment
- Monitoring and control of work undertaken by contractors
- Completion of log books and associated documentation

Competent Person Electrical Low Voltage HTM 06-02

📍 York, Slough, Livingston and On-site | 2 Day | £525^{+VAT}

Course Overview:

This City & Guilds Accredited training course will enable you to gain the knowledge required to carry out the role of Competent Person (Electrical). It can also assist in demonstrating competence during the formal appointment process. The course meets the criteria contained in Appendix 7 of HTM 06-02.

Please note we have the ability to offer this course on-site at client premises and on a bespoke basis.

Who Is This Course For:

This course is aimed at electrical staff with responsibility for the operation or maintenance of installed Low Voltage systems and who may be nominated as a Competent Person within their organisation.

Key Learning Areas Covered In This Course:

- Technical overview of electrical systems and protection concepts
- Awareness of electrical dangers
- Requirements of Electricity at Work Regulations
- Safe working practices with electricity
- Low voltage working procedures for work on equipment made dead
- Receipt of permit to work
- Requirements for live testing and completion of self check form
- Testing of circuits prior to re-energisation
- The relevant content of HTM 06-02



Authorised Person Electrical Low Voltage HTM 06-02 Refresher

APLVR

📍 York, Slough and Livingston | 3 Day | **£895^{+VAT}**

Course Overview:

This course is designed to refresh and update your knowledge of the requirements contained within HTM 06-02 in order to support the process for re-appointment as Authorised Person Low Voltage within a healthcare environment.

Who Is This Course For:

This course is aimed at experienced engineering staff with responsibility for the control, operation or maintenance of installed low voltage systems and who may be appointed as Authorised Person (AP Electrical Low Voltage). This course is solely for current and/or experienced AP's in the healthcare industry.

Key Learning Areas Covered In This Course:

- Requirements of Electricity at Work Regulations
- Review and apply content of HTM 06-02
- Review of working procedures to HTM 06-02
- Control of electrical works by competent persons
- Practical exercises in completion of Safety Programmes and issue of Permits to Work and other safety solutions
- Completion of logbooks and associated documentation

Standby Systems

📍 York and Slough | 3 Day | £895^{+VAT}

Course Overview:

This City & Guilds accredited course covers the key elements involved with the choice, use, and maintenance of Standby systems. The course provides an increased understanding of the Standby system types and topologies.

The Safe Systems element incorporates a tried and tested methodology with references to the JSP Safe Systems of Work, which can be adapted to the learner's own application.

Who Is This Course For:

This course is aimed at the Authorised Person, engineer and technician seeking an overview of Standby systems. The course includes technical detail from manufacturers and OEMs and safe procedures referenced from HSE and other best practice libraries (including JSP)

Key Learning Areas Covered In This Course:

- Generators
- UPS
- Topologies
- Safe working practices
- Isolation
- Regulations
- Compliances
- Roles of personnel
- Background and evolution of Standby systems
- Maintenance

DIESO
UK



**Petroleum spirit
Highly flammable**

**No smoking
No naked lights
No mobile phones**

Switch off engine

Hazardous Areas

Course Name	Code	Length	Price Exc. VAT
Authorised Person MOD Hazardous Areas	APHAZ	3 Day	£895

Training available in York, Slough and On-site



★★★★★

"The trainers make the course"

"The service was great, well organized and well run. Timings were ideal and the facilities were always clean and functional."

Darren - Amey Defence

City & Guilds Accredited
Authorised Person
Hazardous Areas

Authorised Person MOD Hazardous Areas

📍 York, Slough and On-site | 3 Day | **£895**

Course Overview:

This City & Guilds accredited course is designed to assist delegates in gaining the knowledge required to carry out Authorised Person duties and responsibilities in accordance with the requirements of JSP 375 and JSP 482.

Who Is This Course For:

This City & Guilds Accredited course is for current engineering staff with responsibility for the implementation and operation of electrical safe systems of work in MOD hazardous areas. It is also suitable for those who may be appointed as the Authorised Person Electrical Hazardous Areas.

Key Learning Areas Covered In This Course:

- Introduction to hazardous areas
- ATEX/DSEAR regulations
- UK and European standards and MOD requirements
- Electrical equipment for hazardous areas
- Hazardous area classification
- MOD working procedures JSP 375 Volume 3 and JSP 482
- Requirements for implementation of safe systems of work
- Roles and duties of the Authorised Person electrical hazardous areas
- Safety documentation, including the issue of permits to work and sanctions to test
- Co-ordination and liaison with the Hazardous Area Manager and AP Petroleum



**Petroleum spirit
Highly flammable**

**No smoking
No naked lights
No mobile phones
Switch off engine**



Control panel
No mobile phones
Switch off engine

DIESO
UK



Course Name	Code	Length	Price Exc. VAT
Aeronautical Ground Lighting Technician	AGLT	5 Day	£1,385
Authorised Person Aeronautical Ground Lighting	APAGL	3 Day	£895
Aeronautical Ground Lighting Maintenance (Systems Management)	AGLSM	3 Day	£895
Authorised Person Aeronautical Ground Lighting (MOD)	AGLMOD	3 Day	£895
Heliports Visual Aids Principles	HPVA	2 Day	£525
Helicopter Landing Areas for Hospitals	HLAH	2 Day	£525

Training available in York, Slough and On-site



"Practical and real life application of course content"

"Extremely enjoyable course, Tony has a wealth of knowledge across the whole of the AGL industry, including a huge amount of practical knowledge."

Andy - Vivo Defence

City & Guilds Accredited
Aeronautical Ground
Lighting Technician



Aeronautical Ground Lighting Technician

📍 York, Slough and On-site | 5 Day | **£1,385**

Course Overview:

This City & Guilds accredited course will provide you with the skills and knowledge required to carry out the installation and maintenance of Aeronautical Ground Lighting (AGL) systems and equipment. The course is suitable for meeting both Civil airport or Military airfield requirements and standards. It is designed to develop technical knowledge and practical application across the full range of AGL services. It will also help in meeting the competency requirements identified in BS EN 61821:2011 Electrical Installations for Lighting and Beaconing of Aerodromes - Maintenance of Aeronautical Ground Lighting Constant Current Series Circuits.

Who Is This Course For:

This is ideal for engineering staff with the responsibility for the operation, installation or maintenance of AGL systems to either Civil Airport (EASA, UK CAA and ICAO) or MOD Airfield (JSP and RA) standards.

Key Learning Areas Covered In This Course:

- Understanding the use of lighting as a visual aid
- AGL series circuits and system components
- Maintenance standards and procedures
- Operation of constant current regulators
- The application of AGL safe working practices
- AGL control and monitoring systems and airside asset management
- Installation and commissioning requirements - testing and fault finding
- Practical exercises and final assessment exercise

Authorised Person Aeronautical Ground Lighting

📍 York, Slough and On-site | 3 Day | £895

APAGL

Course Overview:

This City & Guilds accredited course will provide you with the skills and knowledge required to carry out Authorised Person duties and responsibilities in compliance with safety rules and procedures which meet the requirements of the Electricity at Work Regulations 1989. It will also help in meeting the competency requirements identified in BS EN 61821:2011 - Electrical Installations for Lighting and Beacons of Aerodromes - Maintenance of Aeronautical Ground Lighting Constant Current Series Circuits.

Who Is This Course For:

This course is designed for engineering staff with responsibility for the control, operation or maintenance of installed AGL systems and who may be appointed as Authorised Person Electrical (AGL). It is suitable for individual Civil Airport AGL Safety Rules and Procedures.

Key Learning Areas Covered In This Course:

- Review of lighting as a visual aid
- Series circuits and system components
- Statutory requirements for electrical systems
- Application of safety rules and procedures (individual airport rules)
- Safe systems of work as applied to AGL circuits
- Correct identification of circuits and practical safe isolation exercises
- Requirements for the completion and issue of safety documentation



Aeronautical Ground Lighting Maintenance (Systems Management)

AGLSM

📍 York and Slough | 3 Day | £895

Course Overview:

This City & Guilds accredited course will provide you with the skills and knowledge required to implement, supervise or manage an aeronautical ground lighting (AGL) system to comply with the required maintenance standards. It will also help in meeting the competency requirements identified in BS EN 61821:2011 – Electrical Installations for Lighting and Beacons of Aerodromes – Maintenance of Aeronautical Ground Lighting Constant Current Series Circuits.

Who Is This Course For:

This course is designed for engineering staff with responsibility for the management, operation or maintenance of installed AGL systems and who wish to develop a more detailed understanding of current procedures and modern practices. It is suitable for meeting ICAO, UK MOD CAA and EASA requirements. As a prerequisite, potential delegates should have previously attended the AGL Technician course or an industry equivalent.

Key Learning Areas Covered In This Course:

- Review of Aeronautical Ground Lighting as a visual aid
- ICAO, EASA, UK CAA and MOD maintenance standards
- Producing and operating a proactive maintenance system
- Photometric measurement and evaluation
- Asset management maintenance systems
- Airside safety procedures
- Power supplies and AGL circuits
- Testing and measurement
- Meeting competency requirements

Authorised Person Aeronautical Ground Lighting (MOD)

Available on Request Only | 3 Day | £895



Course Overview:

This City & Guilds accredited course will provide you with knowledge and understanding of Aeronautical Ground Lighting (AGL) systems found on the MoD Estate. It will also explain typical AGL primary series circuits, power supply equipment and the associated hazards of working on them. The application of MoD's Electrical Safety Rules and Procedures to provide a safe system of work when working on or testing AGL circuits will also be discussed. The course is designed to satisfy the requirements of JSP 375 Volume 3. It will also help in meeting the competency requirements identified in both the Electricity at Work Regulations 1989 and BS EN 61821:2011 – Electrical Installations for Lighting and Beaconing of Aerodromes – Maintenance of Aeronautical Ground Lighting Constant Current Series Circuits.

Who Is This Course For:

This course is designed for staff currently appointed as an Authorised Person Electrical (HV/LV), who are being considered for appointment to cover MoD airfield lighting systems. It will provide an introduction to Airfield Lighting systems currently designed in accordance with MAA Regulatory Article 3515 and earlier documents used on the MoD Estate.

Potential delegates should already be familiar with MoD Electrical safety documents and procedures.

Key Learning Areas Covered In This Course:

- Review of MoD airfield lighting systems used for visual aids
- AGL primary series circuits and typical system components
- Safe systems of work as applied to AGL circuits
- Application of JSP 375 Volume 3 Electrical Safety Rules and Procedures
- Correct identification of circuits and practical safe isolation exercises
- Practice with the completion and issue of MoD safety documentation



Heliports Visual Aids Principles

📍 York and Slough | 2 Day | £525

Course Overview:

Designed to provide delegates with a detailed overview of Visual Aids principles, as it relates to on-shore Heliports (including Helipads). This course will assist in meeting various ICAO and CAA regulations, as well as MAA Regulatory Article 3535 for MOD establishments.

Upon completion, delegates will have an increased understanding of Helipad lighting requirements, Aeronautical Ground Lighting (AGL) supplies and circuits, as well as Helipad Visual Aids layouts.

Who Is This Course For:

Any person involved with the management or day-to-day maintenance of an on-shore Heliport facility. Including individuals responsible for private heliports and those within MOD establishments. Training is designed to enable delegates to meet the requirements of, ICAO Annex 14, Volume II – Document 9261, CAA – CAP 637, CAA – CAP 168 Chapter 12, and MAA – Regulatory Article 3535.

Key Learning Areas Covered In This Course:

- Regulations and standards applied to Heliports
- An introduction to Visual Aids
- Layout options for Heliports
- Heliport lighting requirements
- AGL supplies and circuits
- The risk of electrical hazards
- Parallel and series circuits – interleaving – wiring AGL circuits
- Safe isolation of AGL circuits
- Practical demonstrations of CCRs
- Practical demonstrations of safe isolation
- Practical assessment of safe isolation
- Final written examination



Helicopter Landing Areas for Hospitals

 York and Slough | 2 Day | £525

Course Overview:

Developed as a follow up to our Heliports Visual Aids Principles course, highlighting the additional requirements and options for helicopter landing areas in healthcare premises. This course also covers relevant regulatory documentation, provided by CAA and ICAO.

Upon completion, delegates will have an increased understanding of the standards for helicopter landing areas at hospitals, including but not limited to; down wash regulations, deluge systems, other firefighting equipment requirements and an introduction to the role of the responsible person (including fire safety and emergency procedures).

Who Is This Course For:

Any person involved with the management or day-to-day maintenance of Heliport / Helipad / Helicopter landing area at a hospital. This includes individuals working within Facilities Management (FM), maintenance staff or healthcare professionals who have regular interaction with Air Ambulance services. Training is designed to enable delegates to meet the requirements of, ICAO 9261 Appendix C - Heliport Manual and CAA - CAP 1264 - Standards for Helicopter Landing Areas at Hospitals.

Key Learning Areas Covered In This Course:

- Regulations and standards applied to helicopter landing areas at hospitals
- Additional requirements/options for Visual Aids at hospitals
- Additional safety requirements
- Operational procedures
- Documentation and reporting
- Maintenance protocols
- Downwash effects
- Effects of local area lighting
- Flat Helipads and raised Helipads
- Deluge systems and other firefighting equipment
- Introduction to the role of the Responsible Person including fire safety and emergency response procedures



Mechanical and Pressure Systems



Course Name	Code	Length	Price Exc. VAT
Authorised Person Mechanical and Pressure Systems	APMPS	4 Day	£1,195
Skilled Person Mechanical and Pressure Systems	SPMPS	2 Day	£525

Training available in York, Slough, Livingston and On-site



★★★★★

"Perfect venue for training and development."

"Parking, Venue, tutor (Carl Davies) and rest of the building facilities was excellent as always been. This wasn't my first time at PPL Slough but always the first choice for training, definitely recommended for quality training and great learning atmosphere."

Ilhan - ISS

City & Guilds Accredited
Authorised Person
Mechanical and
Pressure Systems



Authorised Person Mechanical and Pressure Systems

📍 York, Slough, Livingston and On-site | 4 Day | **£1,195**

Course Overview:

Many organisations have adopted JSP 375 Volume 3 Chapter 4 (or parts thereof) as the basis for a Safe System of Work as applied to mechanical systems. For practicable commonality this course is based on the content of this document together with HSG 253 Safe Isolation of Equipment.

Who Is This Course For:

This City & Guilds accredited course is aimed at experienced engineering staff with the responsibility for the implementation of risk management systems and procedures as part of, and in accordance with, their Organisation - Safety Policy. This course has been designed for those with the responsibility for the control, operation and maintenance of an installed mechanical plant and who may be appointed as Authorised Person Mechanical or Pressure Systems. It is also suitable for those with overseeing and audit responsibilities.

Key Learning Areas Covered In This Course:

- Fundamental principles of applied mechanics and thermodynamics
- Mechanical systems and components
- Requirements of pressure systems safety regulations
- Requirements of HASAWA 1974 and delegated legislation
- Safe systems of work associated with mechanical systems
- Functional risk assessments
- Monitoring and audit requirements
- Practical exercises in the completion of safety documentation

Skilled Person Mechanical and Pressure Systems

📍 York, Slough, Livingston and On-site | 2 Day | £525

SPMPS

Course Overview:

This City & Guilds accredited course will enable you to gain the knowledge required to carry out the role of Competent or Skilled Person (Mechanical) and can assist in demonstrating a full understanding of company safety rules and procedures during formal assessment. Many organisations have adopted JSP 375 Volume 3 Chapter 4 (or parts thereof) as the basis for a Safe System of Work as applied to mechanical systems. For practicable commonality this course is based on the content of this document together with HSG 253 Safe Isolation of Equipment. This course is NOT suitable for those persons intending to carry out examinations and inspections in accordance with regulations 8,9 & 10 (written scheme of examination) of the Pressure Systems Safety Regulations (PSSR) 2000

Who Is This Course For:

This is aimed at mechanical staff with responsibility for the operation or maintenance of installed mechanical plant and who may be nominated as a Competent or Skilled Person within their organisation.

Key Learning Areas Covered In This Course:

- Technical overview of mechanical systems components
- Requirements of Pressure Systems Safety Regulations
- Safe system of work associated with mechanical systems
- Receipt of safety documentation



Confined Spaces and Working At Height



Course Name	Code	Length	Price Exc. VAT
Authorised Person Confined Spaces (Commercial)	APCS	4 Day	£1,195
Competent Person Confined Spaces	CPCS	2 Day	£525
Authorised Person Confined Spaces Refresher	APCSR	3 Day	£895
Competent Person Confined Spaces Refresher	CPCSR	1 Day	£285
Authorised Person Confined Spaces (MOD)	CSMOD	5 Day	£1,385
Authorised Person Working At Height (MOD)	APWH	3 Day	£895
Authorised Person Working At Height (Commercial)	APWHC	3 Day	£895

Training available in York, Slough, Livingston and On-site

Authorised Person Confined Spaces (Commercial)

APCS

📍 York, Slough and On-site | 4 Day | **£1,195**

Course Overview:

This City & Guilds accredited course has been developed to follow the advice outlined in the Safe Work in Confined Spaces, Confined Spaces Regulations 1997, Approved Code of Practice, Regulations and Guidance L101, JSP375, Volume 3 Chapter 6 and Procedures for Confined Spaces.

This course does not satisfy the requirements for confined space working within sites controlled by the MOD, please refer to Authorised Person Confined Spaces (MOD) (CSMOD)

Who Is This Course For:

This is aimed at those who have been selected for training to become an Authorised Person (Confined Spaces) with responsibilities to implement, manage and control all aspects of confined space operations ensuring that a safe system of work is in place prior to any confined space activities being permitted.

Key Learning Areas Covered In This Course:

- The current Health & Safety legislation in respect to confined spaces
- Gain an understanding of safe systems of work and complete safety documentation including Permits to Work
- Understand the minimum safety equipment requirements and procedures utilised for safe entry and egress
- Have an awareness for the responsibilities for individuals within the work team, training and fitness requirements
- Understand the actions and reporting procedures needed in respect to response to emergencies
- You will carry out a practical entry into confined spaces using escape breathing apparatus (EBA)



Authorised Person Confined Spaces (MOD)

📍 York, Slough and On-site | 5 Day | **£1,385**

Course Overview:

This City & Guilds accredited course has been developed to comply with JSP375, Volume 3 Chapter 6 and Procedures for Confined Spaces regulations.

Delegates will gain hands-on experience through practical training methods, involving scenarios where Escape Breathing Apparatus (EBA) and Self Contained Breathing Apparatus (SCBA), as well as other appropriate items of PPE are required.

Who Is This Course For:

This is aimed at those who have been selected for training to become an Authorised Person (Confined Spaces) and are expected to work to JSP375, volume 3 chapter 6 specifications at Ministry of Defence sites. This person will have responsibilities to implement, manage and control all aspects of confined space operations ensuring that a safe system of work is in place prior to any confined space activities being permitted.

Key Learning Areas Covered In This Course:

- The current Health & Safety legislation in respect to confined spaces
- Gain an understanding of safe systems of work and complete safety documentation including Permits to Work
- Understand the minimum safety equipment requirements and procedures utilised for safe entry and egress
- Have an awareness for the responsibilities for individuals within the work team, training and fitness requirements
- Understand the actions and reporting procedures needed in respect to response to emergencies
- You will carry out a practical entry into confined spaces using escape breathing apparatus (EBA) and Self Contained Breathing Apparatus (SCBA)

Authorised Person Confined Spaces Refresher

📍 York, Slough and On-site | 3 Day | **£895**

Course Overview:

Where applicable this course follows the advice given in the Safe Work in Confined Spaces; Confined Spaces Regulations 1997, Approved Code of Practice, Regulations and Guidance L101, JSP375 Volume 3 Chapter 6 and Procedures for Confined Spaces.

Who Is This Course For:

This course is aimed at those who have previously been trained and appointed as an Authorised Person (Confined Spaces) and has or currently has responsibilities to implement, manage and control all aspects of confined space operations, ensuring that a safe system of work is in place prior to any confined space.

Key Learning Areas Covered In This Course:

- The current health and safety legislation in respect to confined spaces
- Hazards and risks associated with confined spaces and implementation of appropriate control measures
- Categories of confined spaces, records and registers
- Safe systems of work associated with confined space entry and complete safety documentation including Permits to Work
- The minimum safety equipment requirements and procedures to be utilised for safe entry and egress
- The responsibilities for individuals within the work team, training and fitness requirements
- Activities are permitted

Competent Person Confined Spaces

📍 York, Slough and On-site | 2 Day | £525

Course Overview:

This Competent Person Confined Spaces training course is designed to meet the essential requirements of safe working in confined spaces required by the Confined Spaces Regulations 1997. Approved Code of Practice, Regulations and Guidance (L101) JSP375, Volume 3, Chapter 6 and Procedures for Confined Spaces.

Who Is This Course For:

Primarily this is aimed at operatives who require training for entry into Medium Risk Confined Spaces where the use of continuous gas monitoring and Escape Breathing Apparatus (EBA) is required as part of a control measure based on a risk assessment. The confined space will have been assessed as safe to enter, and to work in, but atmospheric conditions may change due to the nature of the space or work being carried out. There is a requirement to appoint a person in charge and have specific emergency arrangements in place.

Key Learning Areas Covered In This Course:

- Health and safety legislation
- Identifying and classifying confined spaces
- Hazards and risks associated with confined space working
- Problem atmospheres (gases and gas monitoring)
- Work team roles and duties. First aid, medical and training requirements
- Introduction to Confined Space equipment and escape breathing apparatus (EBA)
- Use of Confined Space equipment and practical entry and exit with EBA
- A self-certification fitness questionnaire is to be completed



Competent Person Confined Spaces Refresher

📍 York, Slough, Livingston and On-site | 1 Day | £285

Course Overview:

This Competent Person Confined Spaces Refresher course involves the presence of one or more people, positioned outside the confined space, who have designated responsibilities for controlling the entry into the confined space. The practical element of this course may involve vertical entry using a ladder and fall arrest/recovery winch or man-riding winch. It can also involve horizontal entry, such as walking or climbing into the confined space or working away from the bottom of a vertical entry, with limited use of a rescue lines.

Who Is This Course For:

The course is aimed at operatives who may need to carry out competent person confined space refresher training. This requires the use of gas monitoring and may require the carrying of escape breathing apparatus (ie. foul and storm water sewerage systems). On completion of the course, delegates should be able to continue to operate in medium risk confined spaces, understand the risks that may be present or introduced and ensure that appropriate control measures are in place prior to entry.

Key Learning Areas Covered In This Course:

- Overview of Health & Safety and the Confined Spaces Regulations
- Reminder of "What is a Confined Space?"
- Hazards associated with confined spaces
- Problem atmospheres (gases & gas monitoring)
- Safe systems of work
- Work team roles and duties
- First aid and medical considerations
- Typical confined space equipment and user checks
- User checks and assembly of Escape Breathing Apparatus (EBA)
- Practical entry exercise with gas monitor, harness, tripod and winch and EBA



Authorised Person Working At Height (MOD)

📍 York, Slough, Livingston and On-site | 3 Day | £895

Course Overview:

This City & Guilds accredited course meets the main requirements of JSP 375, Volume 3, Chapter 7, and many other similar safety rules and procedures. On completion of the course, you will have the requisite knowledge to be able to identify and advise on typical working at height activities, and the associated risks. You will also be able to check the competency of operatives, the quality of their equipment, and ensure that the correct control measures and safety documentation is in place prior to issuing a permit for work to be carried out.

Who Is This Course For:

This is for those who have been selected for training to become an Authorised Person (Working at Height). This position has the responsibilities to implement, manage and control all aspects of working at height operations, ensuring that a safe system of work is in place.

Key Learning Areas Covered In This Course:

- Overview of Health and Safety and statutory regulations
- Introduction to Chapter 7 and Scope and limitations of Chapter 7
- Management Arrangements (Hierarchy of Control Measures)
- Roles and duties
- Assessment, appointment, auditing and monitoring
- Climbing teams and authorised climbers
- Personal protective equipment and respiratory protective equipment
- Operating procedures (safety documentation) | rooftop working (HSG33)
- Chapter 27- Preventing Falls and Falling Objects
- Safety Documentation worked examples and scenario

Authorised Person Working At Height (Commercial)

📍 York, Slough, Livingston and On-site | 3 Day | £895

APW/H/C

Course Overview:

This City & Guilds accredited course will provide you with the requisite knowledge to be able to identify and advise on typical working at height activities, and the associated risks. You will also be able to check the competency of operatives, the quality of their equipment, and ensure that the correct control measures and safety documentation is in place prior to issuing a permit for work to be carried out.

Who Is This Course For:

This course has been developed to provide maximum support for those who have been put forward for Authorised person positions with responsibility to implement, manage and control all aspects of Working at Height operations at site level, ensuring that a safe system of work is in place.

Key Learning Areas Covered In This Course:

- Overview of Health and Safety and statutory regulations
- Management Arrangements (Hierarchy of Control Measures)
- Roles and duties
- Assessment, appointment, auditing and monitoring
- Climbing teams and authorised climbers
- Personal protective equipment and respiratory protective equipment
- Operating procedures (safety documentation)
- Rooftop working (HSG33)
- Safety Documentation worked examples and scenario

DIESO
MT

F-54



Danger
Petroleum spirit highly flammable



No smoking



No naked lights



No mobile phones



Switch off engine

Course Name	Code	Length	Price Exc. VAT
Authorised Person Petroleum	APP	4 Day	£1,195
Authorised Person Petroleum Refresher	APPR	3 Day	£895

Training available in York, Slough and On-site



★★★★★

"Excellent course, well delivered."

"PPL's training, as always, was well measured and covered all topics needed to gain a full understanding of the course subject."

Rob - Babcock

City & Guilds Accredited
Authorised Person
Petroleum

Authorised Person Petroleum

📍 York, Slough and On-site | 4 Day | **£1,195**

Course Overview:

This City & Guilds Accredited training course is designed to introduce the Authorised Person (Petroleum) to the requirements of safe working on petroleum installations. It is the Authorised Person's responsibility to ensure that the Safe Systems of Work for installations are implemented, managed and controlled by the appointed Competent Persons (CP). This course has also been developed in line with the requirements of JSP375 Volume 3 Chapter 5 and procedures for Petroleum.

Who Is This Course For:

This is aimed at engineering staff who have the responsibility for the safe handling of petroleum, and who may be appointed as the Authorised Person (Petroleum).

Key Learning Areas Covered In This Course:

- Introduction to petroleum products, characteristics and classification
- Understand the current Health and Safety legislation in respect to petroleum installations
- Hazards and risks associated with petroleum product, and infrastructure
- Overview of petroleum systems and installations
- JSP 375 Vol 3 Chapter 5 – Rules and Procedures, Roles and Duties
- Isolation methodology
- Auditing and monitoring
- Electrical work in petroleum areas
- Testing and safety equipment
- Personal Protective Equipment and Respiratory Protective Equipment
- Assessing and appointing CPs



Authorised Person Petroleum Refresher

📍 York, Slough and On-site | 3 Day | **£895**

Course Overview:

This course is designed to refresh delegates who have been previously trained and appointed as an Authorised Person (AP) to the requirements of safe working on petroleum installations. It is the AP's responsibility to ensure that the Safe Systems of Work for installations are implemented, managed and controlled by the appointed Competent Persons (CP). This course is also in line with the requirements of JSP375 Volume 3 Chapter 5 and procedures for Petroleum.

Who Is This Course For:

This course is aimed at engineering staff who have the responsibility for the safe handling of petroleum, and those who may be appointed as the Authorised Person (Petroleum). As this is a refresher course you must have previously sat our full course or equivalent.

Key Learning Areas Covered In This Course:

- Current Health and Safety legislation in respect to petroleum installations
- Petroleum products, characteristics and classification
- The hazards and risks associated with petroleum product & infrastructure
- Petroleum systems and installations
- Electrical work in petroleum areas
- Isolation methodology
- Testing and safety equipment
- PPE and RPE



PRECISION UK Ltd

PRECISION UK Ltd
CONTROL PANEL
1

PRECISION UK Ltd
CONTROL PANEL
2

250 ml
100
50
100
150
200
250

Pressure Gauge

Medical Gas Pipeline Systems HTM 02-01



Course Name	Code	Length	Price Exc. VAT
Authorised Person Medical Gas Pipeline Systems HTM 02-01	APMGPS	5 Day	£995
Authorised Person Medical Gas Pipeline Systems Refresher HTM 02-01	APMGPSR	3 Day	£795
Competent Person Medical Gas Pipeline Systems HTM 02-01	CPMGPS	5 Day	£995
Competent Person Medical Gas Pipeline Systems Refresher HTM 02-01	CPMGPSR	3 Day	£795
Dental Compressed Air and Vacuum Systems for use in Healthcare	DAVS	2 Day	£525

Training available in York and Slough



"Really Enjoyed The Course"

"Very informative & presented in a way I think all should do. People would learn more if taught the way you do so.

Best course I've been on in my 14 years with the NHS, excellent thanks."

Dave - Northern Care Alliance NHS Group

City & Guilds Accredited
Authorised Person Medical Gas Pipeline Systems Refresher HTM 02-01

Our Facilities

Medical Gas Pipeline Systems

York Campus

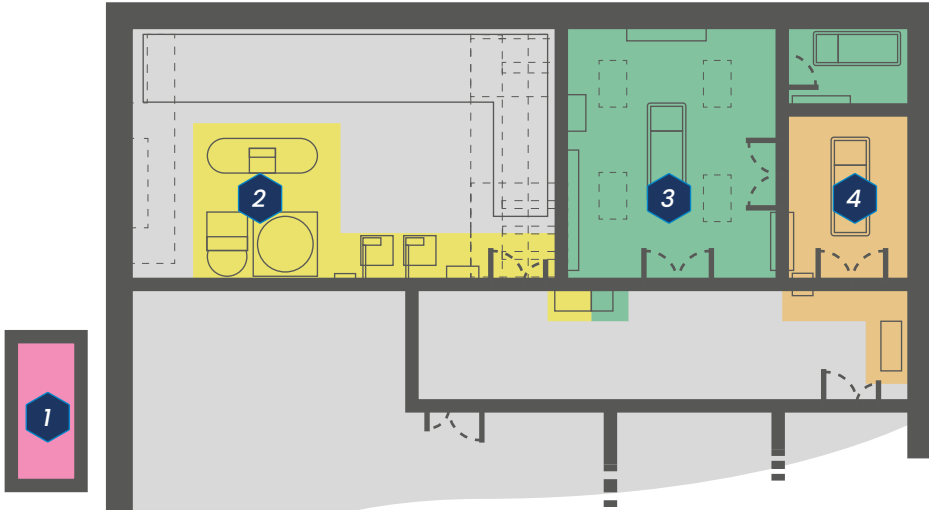

The Importance of Practical Training

Our practical facilities showcase industry standard installations, enabling delegates to gain hands-on experience in the testing and commissioning of equipment found in plant rooms, conventional theatres and anaesthesia rooms, all compliant with HTM 02-01.

By attending either of our AP or CP courses, you will gain transferable skills and knowledge to be able to carry out your duties compliantly and enable you to react effectively to emergency situations, should they arise.



Medical Gas Manifold Supply

Designed to mimic the medical gas supply for a HTM 02-01 compliant manifold room. The supply consists of:

- Medical Air Emergency Reserved Manifold
- Medical Air Automatic Manifold



Medical Gas Plant Room

For use as a practical teaching aid in our AP and CP courses. This room holds:

- Central Alarm System
- 3 Phase Anaesthetic Gas Scavenging System
- Duplex Medical Vacuum Plant
- Duplex Medical Air Plant
- Ventilation Plant Equipment

Slough Centre

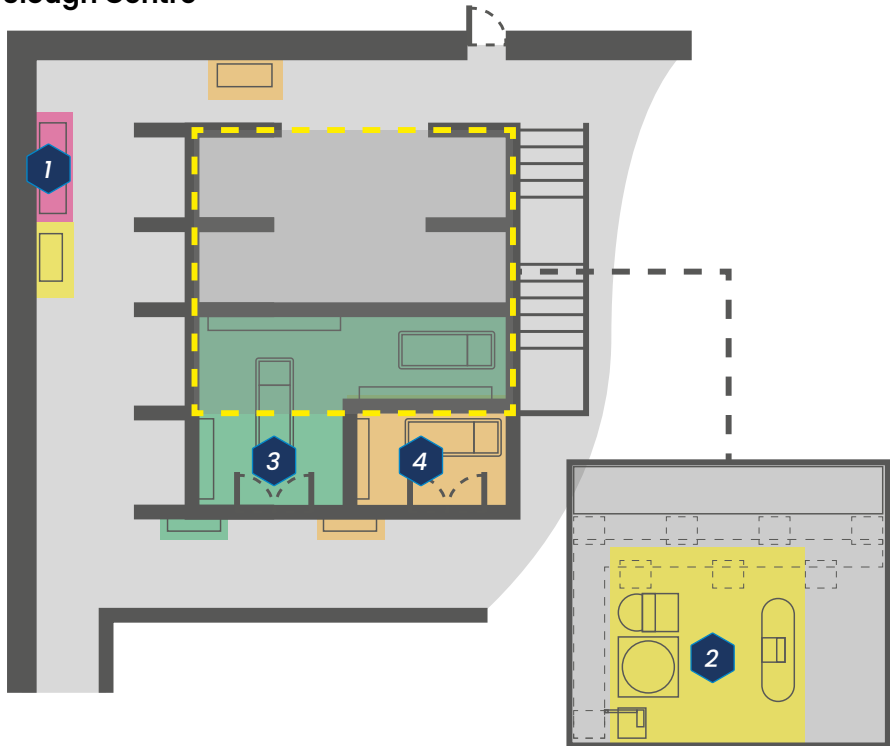

3

Conventional Theatre and Recovery Room

Where delegates require knowledge of real-world applications of medical gases, these rooms contain:

- 2X 3 Gas, Surface Mounted AVSU Module with Digital Alarm and Transducers
- 6 Gas, Surface Mounted AVSU Module with Digital Alarm and Transducers
- Local Alarm
- Various Terminal Units

4

Anaesthesia Room

Along with the Theatre and Recovery rooms, this area is designed to enable testing and commissioning practical works, and holds:

- Duplex 3 Gas, Surface Mounted AVSU Module with Digital Alarm and Transducers
- 3 Gas, Surface Mounted AVSU Module with Digital Alarm and Transducers
- Dental Air Compressor
- Various Terminal Units

Our Facilities

Medical Gas Manifolds



Automatic Changeover Manifold

*MA4 Automatic Change Over Manifold- 650 l/min\
Digital- 2x4 Pin Index, c/w Digital Touchscreen*

This manifold is classified by HTM 02-01 as a primary supply. According to this Health Technical Memorandum, manifold type, capacity and location of all primary, secondary and reserve sources of supply must all be carefully considered and risk assessed during the planning stage, taking into account specific design parameters and need for supply security.



Emergency Reserved Manifold (ERM)

*Emergency Reserved Manifold MA4 to HTM 02-01 -
2x2 Pin Index.*

This manifold is classified by HTM 02-01 as a secondary supply. This must come online automatically via a non-return valve. The number of cylinders must provide a minimum of 4 hours supply, based on the facility's design flowrates. A compressor plant, or synthetic air supply, should always be specified where capacity is in excess of a 2 x 10 manifold capacity.



Back-feed Kit

Backfeed protection device

The back-feed kit is used to supply the medical gases to a ward or department in the event of a main supply interruption and is connected via the NIST or through a terminal unit. This is to be undertaken with the implementation of a permit to work and under the control of the Authorised Person. The back-feed kits are gas specific and are manufactured to be connected to all types of gases.

Our Facilities

Medical Gas Plant



Active Anaesthetic Gas Scavenging System (AAGSS)

AGSS Simplex Unit - 260l/min 3 phase

The AAGSS is used for the extraction of the waste anaesthetic gas from the patient breathing circuit ensuring compliance to the CoSHH regulations for the theatre environment. The system is extended into the theatre and anaesthetic room to enable practical testing and commissioning for both the APs and CPs.



Medical Vacuum Plant

Med Vac Plant 270l/min Duplex - HTM 02-01, c/w Digital Touchscreen

Classified as a primary source only, this duplex plant will work in conjunction with a third pump to meet the supply recommendations of HTM 02-01.

The use of medical vacuum plant systems for providing dental vacuum is not advised according to HTM 02-01.



Medical Air Plant

Med Air Plant 420l/min Duplex - HTM 02-01 c/w Digital Touchscreen

Working in conjunction with our ERM, this duplex system supplies medical air to our theatre, recovery and anaesthesia rooms. Sited with all-round access for maintenance purposes and allowing adequate flow for air intake to the compressors.



Dental Air Plant

*Silent Running -44 Dew Point
HTM 2022 Compliant*

The dental system is a self-contained package including the compressor and twin desiccant dryer system, integral to the single cabinet. This system can cater for a single chair to 20 chair installation. Also used to run sterilisation and pharmaceutical supply within Medical Gas Pipeline Systems.



Authorised Person Medical Gas Pipeline Systems HTM 02-01

📍 York and Slough | 5 Day | £995

Course Overview:

This City & Guilds accredited course provides you with a detailed overview and understanding of HTM 02-01. Attending this course enables you, as a prospective AP (MGPS), to carry out your duties effectively and compliantly with respect to medical gas systems. This will also cover your ability to react correctly to emergency situations. During the course, you will take a number of written assessments and a multiple choice examination. Upon successful completion, you will be issued with a City & Guilds accredited certificate of achievement.

Who Is This Course For:

This course is designed for healthcare/estates officers and other personnel, who are looking to be appointed as an Authorised Person (MGPS) and require a detailed level of understanding that ensures they have the knowledge and competence to manage a medical gas system safely to compliance.

Key Learning Areas Covered In This Course:

- Understanding of the HTM 02-01 and its structure and purpose
- Statutory requirements
- Characteristics and safety requirements of medical gases
- Storage and management of medical gas cylinders
- Correct use and management of the medical gas permit to work system
- Management and assessment of Competent Persons and medical gas contractors
- Safe management of medical gas plant and distributional pipework systems
- Design overview and installation practices of medical gas systems
- Validation and verification of medical gases
- Overview of an Operational Policy and Safe Operating Procedures
- Requirements of the Medical Gas Group
- Management of documentation
- Compliant management of medical gas maintenance
- The provision of emergency supplies
- Risk assessments and method statements

Authorised Person Medical Gas Pipeline Systems Refresher HTM 02-01

📍 York and Slough | 3 Day | £795

APMGPSR

Course Overview:

This City & Guilds accredited course is a condensed version of our full Authorised Person medical gas pipeline systems course. Attending this course enables you, as a prospective AP (MGPS), to carry out your duties effectively and compliantly with respect to medical gas systems. This will also cover your ability to react correctly to emergency situations. During the course, you will take a number of written assessments and a multiple choice examination. Upon successful completion, you will be issued with a City & Guilds accredited certificate of achievement.

Who Is This Course For:

This course is designed for Authorised Persons (MGPS) who are currently an AP within a healthcare facility and have been for a minimum of three years. This course is an intensive course suitable for those, who along with taking the role and responsibility, have a good knowledge of their system, the requirements and general principles of pipeline systems.

Key Learning Areas Covered In This Course:

- Understanding of the HTM 02-01 and its structure and purpose
- Statutory requirements | Characteristics and safety requirements of medical gases
- Storage and management of medical gas cylinders
- Correct use and management of the medical gas permit to work system
- Management and assessment of Competent Persons and medical gas contractors
- Safe management of medical gas plant and distributional pipework systems
- Design overview and installation practices of medical gas systems
- Validation and verification of medical gases
- Overview of an Operational Policy and Safe Operating Procedures
- Requirements of the Medical Gas Group and management of documentation
- Compliant management of medical gas maintenance
- The provision of emergency supplies
- Risk assessments and method statements



Competent Person Medical Gas Pipeline Systems HTM 02-01

📍 York and Slough | 5 Day | £995

Course Overview:

This City & Guilds accredited course has been designed to provide a comprehensive and in-depth knowledge and understanding of safety and compliance when working with medical gas systems. Throughout this course HTM 02-01 will be covered in-depth to enable you to understand your role and responsibilities.

This course is made of 2 assessments, a scenario and a multiple-choice examination. Upon successful completion of the written assessment, you will be issued with a City & Guilds accredited certificate of achievement which can be presented to your authorising party for appointment.

Who Is This Course For:

This course has been designed for healthcare/estates officers and other personnel, who are looking to be appointed as a Competent Person (MGPS) and require a detailed level of understanding to work with medical gas systems, safely and compliantly.

Key Learning Areas Covered In This Course:

- Understanding of the HTM 02-01 and its structure and purpose
- Typical Gas System design and operation
- Understanding of gas system schematic diagrams
- Basic fault finding, including typical responses to alarm/ emergency conditions
- MGPS Maintenance and Testing Requirements, including practical tests
- Introduction to the MGPS Permit to Work System, as detailed within HTM 02-01
- Emergency Procedures

Competent Person Medical Gas Pipeline Systems Refresher HTM 02-01

📍 York and Slough | 3 Day | £795

CPMGPSR

Course Overview:

This course provides you with an overview and a reminder of what is required within HTM 02-01. Attending this course allows you, as a prospective CP (MGPS), to carry out your duties effectively concerning medical gas supply plant and all medical gas distribution systems. This also covers your ability to react correctly to emergency situations. Upon successful completion of the written assessment, you will be issued with a City & Guilds accredited certificate of achievement.

Who Is This Course For:

This course has been developed for those already appointed as the Competent Person (MGPS) within a healthcare facility and have been for a minimum of three years. This course is an intensive course suitable for those who have a good knowledge of their system, the requirements and general principles of pipeline systems.

For CPs that have infrequent contact with medical gas pipeline systems, we recommend our full 5 day course.

Key Learning Areas Covered In This Course:

- Introduction to basic gas safety and HTM 0201
- Typical Gas System design and operation
- Understanding of gas system schematic diagrams
- Basic fault finding, including typical responses to alarm/ emergency conditions
- MGPS Maintenance and Testing Requirements, including practical tests
- Introduction to the MGPS Permit to Work System, as detailed within HTM 0201
- Emergency Procedures



Dental Compressed Air and Vacuum Systems for use in Healthcare

📍 York and Slough | 2 Day | £525

Course Overview:

Our City and Guilds accredited Dental Air and Vacuum Systems (DAVS) course provides a detailed overview of the managing documents HTM02-01 and HTM2022 Supplement 1. The course will cover all the knowledge that is required to work on and manage a Dental Air and Vacuum System (DAVS).

It will specifically cover legislation, installation, maintenance, and management of the systems, as well as compliance with the requirements of HTM 02-01 and HTM 2022 Supplement 1. The course has both theory and practical elements with a scenario and examination at the end. Those who attend and successfully complete the course and pass the examination will receive a City & Guild accredited certification of achievement.

Who Is This Course For:

The course is designed for healthcare/estates/private facilities that work with Dental Air or Vacuum systems, or the management, maintenance, or installation of these systems. You must have a professional level of understanding and knowledge to be involved with a DAVS system; this course will enable you to achieve this. This qualification is a requirement for those responsible for or working on a DAVS system.

Key Learning Areas Covered In This Course:

- Introduction to Medical Gases
- Personal Protective Equipment (PPE)
- General Principles of Dental Air and Dental Vacuum
- History of Dentistry and Air Compressors
- Management Responsibilities and Guidelines
- Regulations and Legal Responsibilities in line with CQC, HSE, HTM 2022 Supplement 1, PSSR and JSP 375 | Statutory Requirements
- System Design and Operational Procedures | Permits to Work
- Modification of Existing Dental Air Systems
- Commissioning (Validation and Verification)
- An overview of Electrical supply requirements
- Practical Demonstration | Assessed scenario work and final examination





Ventilation HTM 03-01



Course Name	Code	Length	Price Exc. VAT
Authorised Person Ventilation HTM 03-01	APV	5 Day	£1,385
Authorised Person Ventilation Refresher HTM 03-01	APVR	3 Day	£895
Competent Person Ventilation HTM 03-01	CPV	3 Day	£895
Validation and Verification of Healthcare Ventilation Systems HTM 03-01	VVH	3 Day	£895

Training available in York, Slough and On-site



★★★★★

"Great and effective course."

"Good course, good resources – hands on testing rig was like "in the real world" The lecturer was well informed and supportive"

Delegate Review – Hampshire Hospitals NHS Foundation Trust

City & Guilds Accredited
Authorised Person Ventilation
HTM 03-01

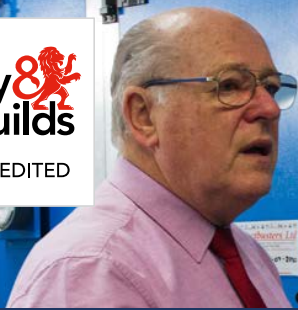

Authorised Person Ventilation HTM 03-01

📍 York, Slough and On-site | 5 Day | **£1,385**

Course Overview:

This course has been developed to provide the necessary information to understand the core duties and responsibilities of the Authorised Person following HTM 03-01 and other associated guidance. The course provides guidance on the legal requirements, design implications, maintenance and operation of ventilation within healthcare premises. It will also cover the inspection and verification requirements as well as the compulsory measurements of performance to ensure the system achieves minimum standards and operates to an acceptable performance level and remains fit for purpose.

Who Is This Course For:

This course has been developed for healthcare managers, design engineers, estates and operations managers, technical staff and consultants who require an understanding of how to manage specialised ventilation systems in healthcare premises.

Key Learning Areas Covered In This Course:

- Understand the standards of design & installation of NHS ventilation systems
- Principal Health & Safety issues associated with vent systems within hospital premises
- Legislation applicable to ventilation systems
- Need for and location of smoke & fire dampers and the function, of pressure stabilisation methods
- Vapour compression refrigeration system, and its relationship with air conditioning
- Understand the function of and maintenance requirements of system heat exchangers
- Humidification and de-humidification, explain its use within the NHS
- What precautions should be in place in NHS ventilation and air conditioning systems to control Legionella.
- Principles of psychrometry and its use for explaining ventilation processes.
- Inspection and verification of critical ventilation systems. Plus practical application.
- Instruments used to collate information from the ventilation systems and their practical use.
- Safe System of Work and the NHS risk assessment process model.

Authorised Person Ventilation Refresher HTM 03-01

📍 York, Slough and On-site | 3 Day | **£895**

APVR

Course Overview:

This course has been developed to provide the necessary information to refresh the duties and responsibilities of the Authorised Person as detailed within HTM 03-01 and other associated guidance. The course covers the legal requirements, design implications, maintenance and operation of specialist ventilation within healthcare premises. It will also cover the inspection and verification requirements together with the compulsory measurements of performance to ensure the system achieves minimum standards, operating to an acceptable performance level and remains fit for purpose.

Who Is This Course For:

This course has been developed for existing Authorised Persons Ventilation, who require an understanding of how to manage specialised ventilation systems in healthcare premises to become eligible for reappointment.

Key Learning Areas Covered In This Course:

- Understand the standards of design & installation of NHS ventilation systems
- Principal Health & Safety issues associated with vent systems within hospital premises
- Legislation applicable to ventilation systems
- Need for and location of smoke & fire dampers and the function of pressure stabilisation methods
- Understand the function of and maintenance requirements of system heat exchangers
- Humidification and de-humidification, explain its use within the NHS
- What precautions should be in place in NHS ventilation and air conditioning systems to control Legionella.
- Principles of psychrometry and its use for explaining ventilation processes
- Inspection and verification of critical ventilation systems.
- Instruments used to collate information from the ventilation systems

Competent Person Ventilation HTM 03-01

CPV

📍 York, Slough, Livingston and On-site | 3 Day | £895

Course Overview:

This course has been developed to provide the necessary information to understand the duties & responsibilities of the nominated Competent Person (HTM 03-01). The course will provide awareness of the different types of ventilation and air-conditioning systems, their component parts and typical layout that conform to healthcare applications. The course will identify the inspection, operation and maintenance activities required and are carried out safely without hazard to staff, patients or members of the public. Those required to inspect, verify or maintain ventilation equipment will need to show competence. You should have sufficient knowledge of correct operation and be able to recognise faults.

Who Is This Course For:

This course has been developed for operations managers technical staff and consultants who require an understanding of how to operate and maintain specialised ventilation systems in healthcare premises.

Key Learning Areas Covered In This Course:

- Types and purposes of ventilation systems within the NHS
- Statutory comfort standards requirements and sources of Department of Health and Industry guidance
- Identifying the role of smoke and fire dampers, their maintenance and inspection requirements
- Identifying the essential components of an air conditioning system
- Identifying appropriate filter grades required for NHS ventilation systems
- Humidification and de-humidification, explain its use within the NHS
- What precautions should be in place in NHS ventilation and air conditioning systems to control Legionella.
- Describe the function of control systems within ventilation systems
- Inspection and verification of critical ventilation systems. Plus practical application.
- Instruments used to collate information from the ventilation systems, and their practical use.
- Safe System of Work and the NHS risk assessment process model.

Validation and Verification of Healthcare Ventilation Systems HTM 03-01

VVH

📍 York and Slough | 3 Day | £895

Course Overview:

This 3 day City & Guilds accredited course has been developed to provide delegates with the necessary understanding of commissioning, validation and verification of ventilation systems in the healthcare environment required by HTM 03-01 and its associated documents. It will give guidance on the physical inspection and measurement of actual performance the systems and the production and understanding of verification reports.

Who Is This Course For:

This course has been designed for those contracted to undertake the inspection and measurement of critical systems performance in accordance with the requirements of HTM 03-01.

The course would also benefit healthcare (operations and projects) managers, Authorising Engineer ventilation (AE(V), Authorised Person(s) Ventilation AP(V), those who are required to serve on the multidisciplinary Ventilation safety group (VSG) and technical staff. Those attending the course would find it helpful to have an appreciation of the ventilation strategies encountered on the health estates and the verification procedures outlined in HTM 03-01 for these systems.

Key Learning Areas Covered In This Course:

- The Commissioning & Validation Process
- Annual Verification and Performance Testing
- The Measurement of All System Supply and Extract Air-flow Rates
- The Calculation of Room Air-change Rates If Applicable
- The Measurement of Room Differential Pressures If Applicable
- The Measurement of Room Noise Levels
- Temperature, Humidity and Any Application Specific Air Velocity Measurements
- A Check of the Control Functions



Electrical Installations



Course Name	Code	Length	Price Exc. VAT
18th Edition Wiring Regulations City & Guilds 2382-22	2382-22	3 Day	£500
Inspection, Testing and Certification of Electrical Installations City & Guilds 2391-52	2391-52	7 Day	£1,155
In-Service Inspection and Testing of Electrical Equipment (PAT Testing) City & Guilds 2377-77	2377A2	2 Day	£475
Fundamental Inspection and Electrical Testing City & Guilds 2392-10	2392	4 Day	£750
Design and Verification of Electrical Installations City & Guilds 2396	2396	5 Day	£875
Electric Vehicle Charging Equipment Installation City & Guilds 2919-01	2919	2 Day	£455
18th Edition Wiring Regulations Amendment 2 - Update	2382-UP	1 Day	£320

Training available in York, Slough and Livingston

18th Edition Wiring Regulations | City & Guilds 2382-22

📍 York, Slough and Livingston | 3 Day | **£500**

Course Overview:

This City & Guilds course will enable you to demonstrate a detailed knowledge of the IET Wiring Regulations 18th Edition known as BS7671:2018 (Amendment 2 2022) Requirements for Electrical Installations.

This course is also available as an on-site event. Please contact our account management team for more information.

Who Is This Course For:

This course is aimed at those involved with the design, installation or testing of electrical installations in accordance with the 18th Edition of the IET Wiring Regulations.

Key Learning Areas Covered In This Course:

- Scope, object and fundamental principles of BS7671:2018
- Electrical definitions
- Assessment of general characteristics
- Requirements of protection for electrical safety
- Selection and erection of equipment
- Electrical inspection and testing
- Special installations or locations
- Use of the information within BS7671:2018 appendices
- Energy efficiency
- Prosumer low-voltage electrical installations
- Protection against fire - installation of arc fault detection devices (AFDDs)
- Protection against transient over voltage
- Assessment includes a two hour online multiple-choice exam

Inspection, Testing and Certification of Electrical Installations | City & Guilds 2391-52

📍 York and Slough | 7 Day | £1,155

2391-52

Course Overview:

This City & Guilds course replaces the previous City & Guilds 2394, 2395 and earlier 2391-10 courses. This seven day course combines both the new 2391-50 and 2391-51 into one course saving you five days over doing both courses separately. This course will enable you to demonstrate the knowledge and skills required to carry out inspection and testing of electrical installations in accordance with the requirements of Part 6 of BS7671 and the Institution of Engineering Technology's Guidance Note 3 (GN3).

Prior to attending this course you should have completed an appropriate qualification in electrical installation and possess a good working knowledge of the industry.

See our website for a full list of prerequisites for this course.

Who Is This Course For:

The course is aimed at practising electricians who wish to obtain a recognised qualification in inspection and testing, including both periodic inspection and initial verification. Delegates should already hold an 18th Edition Certificate and be familiar with the IET's GN3. PPL also strongly recommend having suitable practical experience of testing prior to attending this course.

Key Learning Areas Covered In This Course:

- Understand the reasons for inspecting and testing electrical installations
- Safe isolation of electrical circuits and installations
- Requirements for completing initial inspection and verification
- Selection and use of suitable test equipment
- Requirements for testing circuits prior to energisation
- Requirements for testing circuits after energisation
- Understanding and evaluation of test results
- Completion of appropriate test certificates and associated documentation
- Safety of systems and equipment prior to completion of inspection and testing
- Classification categories for different types of fault

In-Service Inspection and Testing of Electrical Equipment (PAT Testing) | City & Guilds 2377-77

📍 York, Slough and Livingston | 2 Day | £475

Course Overview:

This two day City & Guilds' course has been designed for those with electrical experience, who want to cover the new Institution of Engineering and Technology In-service inspection and testing of electrical equipment 5th edition.

A notable change from the old City & Guilds Portable Appliance Testing course, is the focus on all electrical equipment, both portable and installed - moving away from the traditional "Portable" terminology.

The largest change to the 5th edition is its move towards a risk assessment based inspection, with all inspection and testing of equipment to be carried out following an implemented electrical risk assessment. Throughout the course you will learn how to structure, implement and document this risk assessment and how to carry out the practical aspects of testing.

Upon completion of this City & Guilds electrical technical course, you will gain the working knowledge to ensure the safety of electrical equipment in accordance with the newest codes of practices. In addition to the essential knowledge you will gain - this City & Guilds accredited certificate is formal recognition of your skills and experience, which can improve your career prospects and provide new opportunities to progress into other electrical roles.

To sit this course you should be a holder of the 18th Edition wiring regulations BS7671:2018, and - At least one of the following :-

- An ECS card,
- JIB electrician grade card
- Have successfully completed an NVQ based electrotechnical apprenticeship or technical certificate to level 3
- Be familiar with the electrical systems and hazards electricity can bring.



Who Is This Course For:

This course has been designed for those with an established electrical background and a good understanding of electrical testing, who want to or currently have the responsibility of in-services inspection and testing of electrical equipment. It is important to remember that if you are the duty holder of inspection and testing, it is essential that you are up to date with the latest approved codes of practice to ensure the safety of the site.

This course is intended for those with an established electrical background and a good understanding of testing. The course covers both management and the practical aspects of testing and is ideal for those looking to offer electrical equipment testing/ portable appliance testing as a service. It is recommended that you have successfully completed an NVQ based electrotechnical apprenticeship or technical certificate to Level 3.

Key Learning Areas Covered In This Course:

- Equipment construction
- Inspection
- Combined inspection and testing
- Recording and use of instruments
- Visual inspection
- Class one and class two tests
- Continuity tests
- Functionality tests
- Insulation tests
- Risk Assessment

Fundamental Inspection and Electrical Testing | City & Guilds 2392-10

📍 York and Slough | 4 Day | £750

Course Overview:

This City & Guilds course will provide you with the skills, knowledge and confidence to inspect and test fundamental installations and to conduct the initial verification.

Who Is This Course For:

This is aimed at practising electricians who have not carried out inspection and testing since qualifying, or who require some updated training. It is also suitable for those with limited experience of inspection and testing of electrical installations who wish to develop their skills in this area.

Key Learning Areas Covered In This Course:

- Understand safe isolation of electrical circuits and installations
- Requirements for inspecting, testing and recording of installations
- Requirements for completing an initial verification
- Requirements for testing before circuits are energised
- Testing of energised installations
- Interpretation of test results
- Requirements for completion of electrical installation certificate
- Assessment incorporates an online exam and a practical assessment



Design and Verification of Electrical Installations | City & Guilds 2396

📍 York and Slough | 5 Day | £875

2396

Course Overview:

This City & Guilds level 4 qualification will provide you with the knowledge and techniques required to professionally design, specify, install and test electrical installations. Attending this course will assist you, as an electrical contractor, to carry out your duties to meet appropriate legislation.

Available Exam Dates

Thursday 8th June 2023

Thursday 7th December 2023

Who Is This Course For:

Designed for electrical professionals, consultants and engineers who are responsible for the electrical design, specification, installation and testing process. For this advanced course it is recommended that delegates have previously attended the 18th Edition Wiring Regulations and 2391 courses, without these qualifications you will find the course extremely challenging to undertake.

This is a great follow-on course for anyone wanting to up-skill and expand their electrical installation training to be able to design and verify electrical systems. Expanding your portfolio to include this level 4 qualification provides formal recognition of your skills and can provide new opportunities to progress into more specialist electrical work.

It is recommended that delegates have previously attended the 18th Edition Wiring Regulations and 2391 courses.

Key Learning Areas Covered In This Course:

- Design of electrical installations including all necessary calculations
- Design, verification and inspection of electrical installations in compliance with current safety legislation and BS7671
- Verification that designs comply with the relevant regulations
- Conduct of an initial verification of a new electrical installation
- Guidance and support to assist completion of a 40 hour design project

A close-up photograph of a person's hand holding a white and green electric vehicle charging cable. The background is blurred, showing what appears to be a charging station.

Electric Vehicle Charging Equipment Installation | City & Guilds 2919-01

2919

 York and Slough | 2 Day | **£455**

Course Overview:

This City & Guilds training course will allow you to take advantage of the surge of interest in the domestic and commercial electric vehicle market. It will provide you with the skills and knowledge required to install dwelling and on street charging points.

Who Is This Course For:

This is aimed at qualified electricians who wish to include the installation of electrical vehicle charging equipment as part of their work. Delegates should have already completed an 18th Edition Course, and be familiar with the IET Code of Practice. We also strongly recommend having practical experience of inspection and testing prior to attending this course.

Key Learning Areas Covered In This Course:

- Introduction, BS7671 section 722 and the IET Code of Practice
- Modes of charging, Electrical Vehicle Supply Equipment (EVSE) and DNO restrictions
- Installation practices, risk assessment, earthing, protection, labelling and practical exercises
- On street, commercial and industrial situations
- Inspection and commissioning
- Certification and notification to DNO

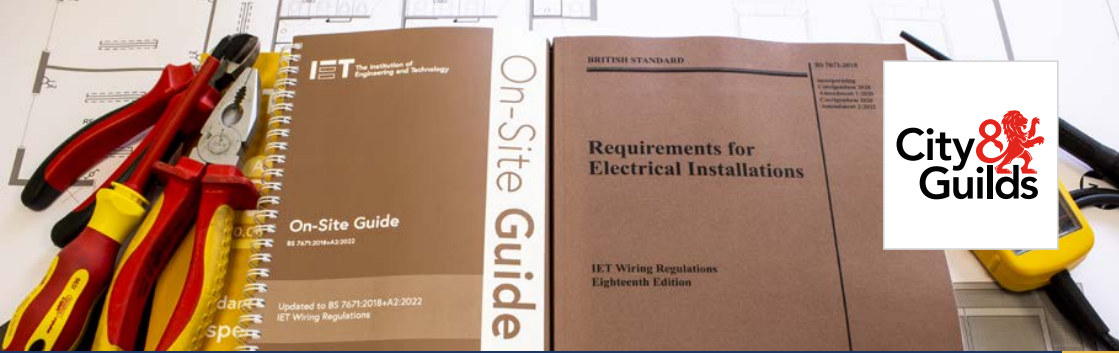

18th Edition Wiring Regulations Amendment 2 – Update

📍 York and Slough | 1 Day | £320

2382-UP

Course Overview:

This course will enable you to demonstrate a detailed knowledge of the updates to the IET Wiring Regulations 18th Edition known as BS7671:2018 (Amendment 2 2022) Requirements for Electrical Installations, since Amendment 1 2020. This course is also available as an on-site event. Please contact our account management team for more information.

At the end of this course, you will be assessed to the City & Guilds 2382-22 question bank.

Who Is This Course For:

This course is aimed at those involved with the design, installation or testing of electrical installations in accordance with the 18th Edition of the IET Wiring Regulations. If you wish to attend this course, you must be able to demonstrate the necessary skills and knowledge required by BS7671:2018 (Amendment 1 2020), and hold a relevant qualification (2382-18 Qualification).

Key Learning Areas Covered In This Course:

- Scope, object and fundamental principles of BS7671:2018
- Electrical definitions and assessment of general characteristics
- Requirements of protection for electrical safety
- Selection and erection of equipment
- Electrical inspection and testing | Special installations or locations
- Use of the information within BS7671:2018 appendices
- Energy efficiency
- Prosumer low-voltage electrical installations
- Protection against fire – installation of arc fault detection devices (AFDDs)
- Protection against transient over voltage
- Assessment includes a two hour online multiple-choice exam

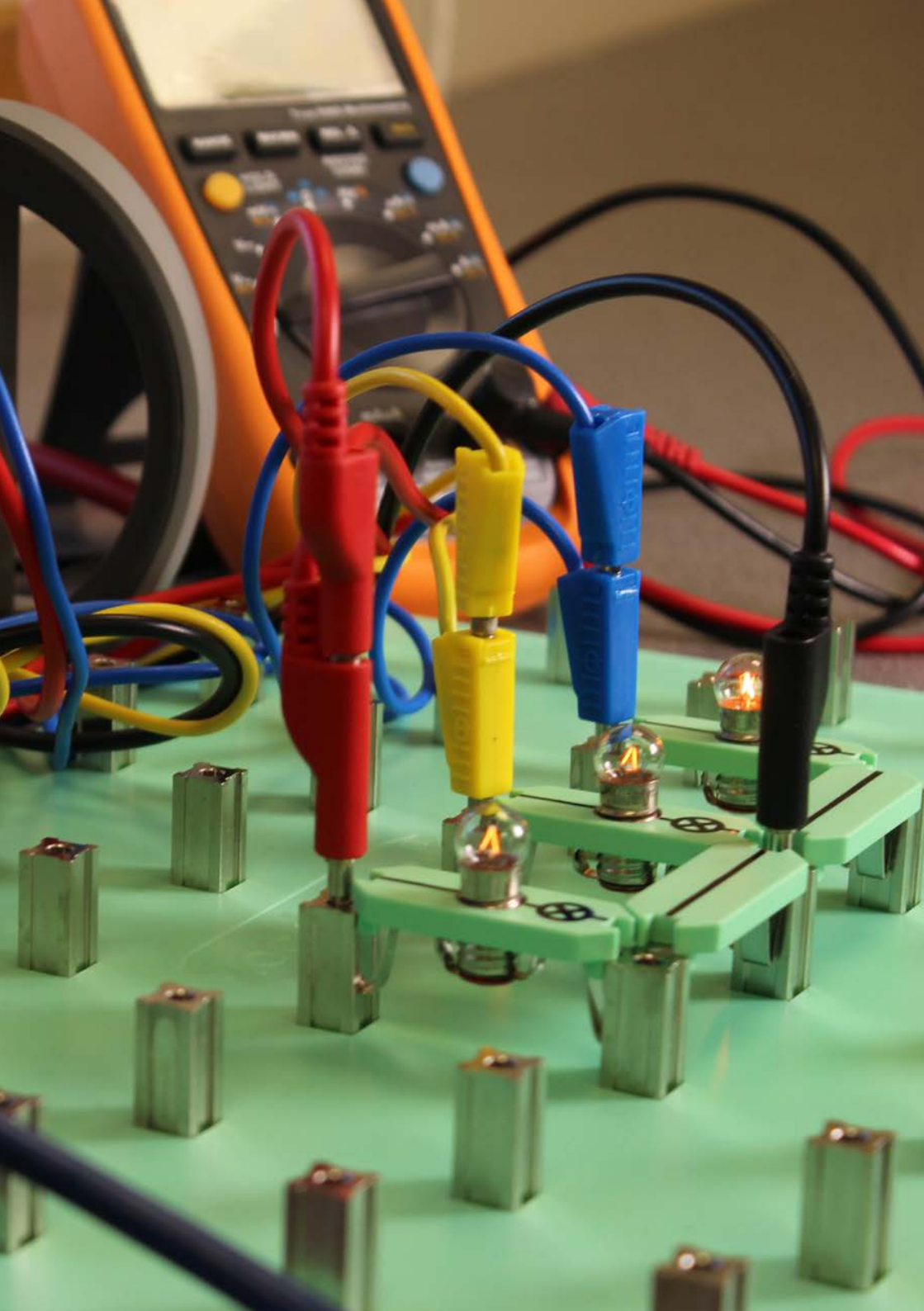

Mechanical and Electrical Conversion



Course Name	Code	Length	Price Exc. VAT
Electrical to Mechanical Conversion	EMC	5 Day	£1,210
Mechanical to Electrical Conversion	MEC	5 Day	£1,210

Training available in York, Slough, Livingston and On-site



★★★★★

"Excellent course and venue."

"Excellent course and venue. Looking forward to going back for my next one. Course tutor was very knowledgeable and kept it interesting."

Andrew - York Teaching Hospitals Facilities Management

City & Guilds Accredited
Electrical to Mechanical
Conversion

Electrical to Mechanical Conversion

📍 York, Slough and Livingston | 5 Day | £1,210

Course Overview:

This City & Guilds accredited course will enable you to gain a basic knowledge of mechanical principles and concepts, as well as an understanding of mechanical plant operation and isolation requirements of plant and pressure systems.

Who Is This Course For:

This course is aimed at staff working within a Mechanical & Electrical environment who would benefit from increased awareness of mechanical principles and practices as part of their current role. It also provides a foundation course for those likely to undertake other mechanical courses.

Key Learning Areas Covered In This Course:

- Key aspects of UK legislation
- Fundamental mechanical principles, including heat transfer, fuels and combustion
- Pumps, systems and components including valve types and heat exchangers
- Refrigeration and air conditioning systems
- Pressure plant including steam
- Hot water plant and water treatment
- Compressed air plant and hydraulic systems
- Plant operating procedures – start up and shut down
- Fire protection and shutdown systems associated with mechanical installations
- Maintenance strategies and procedures

Mechanical to Electrical Conversion

📍 York, Slough, Livingston and On-site | 5 Day | **£1,210**

Course Overview:

This City & Guilds accredited course has been developed to provide delegates with a basic knowledge of electrical theory as well as an understanding of electrical machine principles and isolation requirements of electrical plant for mechanical work.

Who Is This Course For:

This course is aimed at those working within a mechanical and electrical environment who would benefit from increased awareness of electrical principles and practices as part of their current role. It is also a good foundation course for those likely to undertake other electrical courses.

Key Learning Areas Covered In This Course:

- Requirements of the Electricity at Work Regulations and dangers of electricity
- Electrical safe systems of work including practical isolation exercises
- Electrical circuit theory and practical use of measuring instruments
- Low Voltage protection devices
- Requirements of BS7671:2018 (2022)
- Single and three phase motors and associated starters
- Inverter drives
- Connection and verification of electric motor wiring
- Motor fault finding
- Final assessment exercise

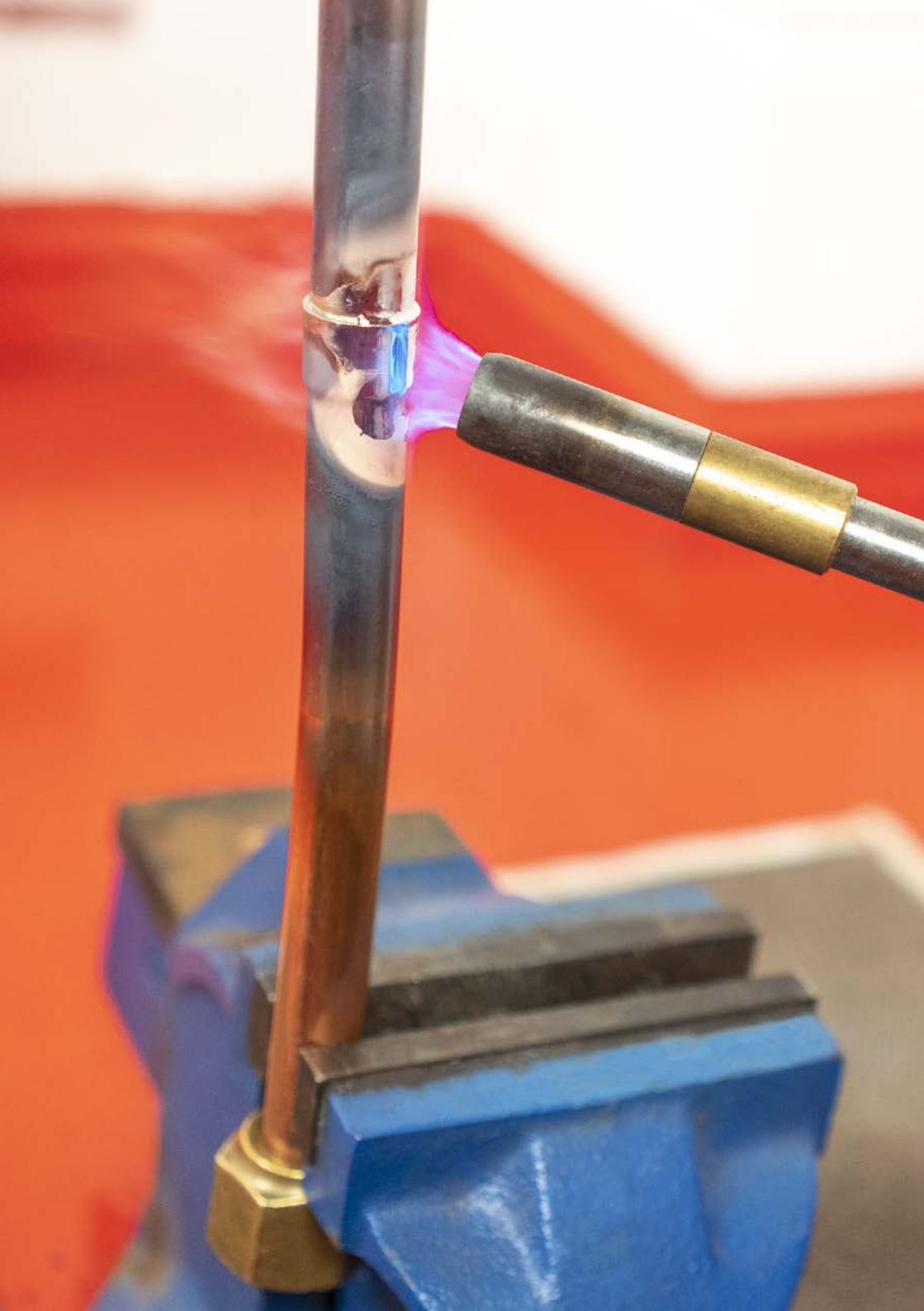

F-Gas Handling



Course Name	Code	Length	Price Exc. VAT
F-Gas (Category 1) City & Guilds 2079-11	FCAT1	5 Day	£975
F-Gas (Category 2) City & Guilds 2079-12	FCAT2	5 Day	Price on Request
F-Gas (Category 3) City & Guilds 2079-13	FCAT3	2 Day	Price on Request
F-Gas (Category 4) City & Guilds 2079-14	FCAT4	2 Day	£495
Hydrocarbon Qualification City & Guilds 6187-21	6187	1 Day	£325
F-Gas Compliance	FGCOM	2 Day	£525
Introduction to Air Conditioning	IAC	3 Day	£800

Training available in York, Slough, Livingston and On-site



F-Gas (Category 1) | City & Guilds 2079-11

📍 York, Slough and Livingston | 5 Day | **£975**

Course Overview:

This City & Guilds course will provide you with the knowledge and practical skills required to work on the installation, service, maintenance, recovery and leakage checking of stationary refrigeration, air conditioning and heat pump equipment with a charge more than 3kg or 6kg (if hermetically sealed).

Who Is This Course For:

This is aimed at those working within the refrigeration and air-conditioning industry who need to meet the legal requirements for working with fluorinated gases, and other ozone depleting substances.

Key Learning Areas Covered In This Course:

- Basic systems, principles and units and how they relate to theory and thermodynamics of vapour compression cycles and refrigerants
- Causes and effects of global warming and ozone depletion
- Identification of air conditioning and heat pump components, functions and leakage risk
- Hazards and safe working practices
- Construction and examination of pipe work
- Recovery of refrigerant and oil and prepare for disposal
- Pressure testing, evacuation and record completion
- Refrigerant charging, leak checking and record keeping
- Fabrication and fitting of mechanical and brazed joints

F-Gas (Category 2) | City & Guilds 2079-12

 York and Slough | 5 Day | **Price on Request**

Course Overview:

This City & Guilds course will provide you with the knowledge and practical skills to work on the installation, service, maintenance and leakage checking of stationary refrigeration, air conditioning and heat pump equipment with a charge of less than 3kg (6kg if hermetically sealed).

Who Is This Course For:

This is aimed at those working within the refrigeration and air-conditioning industry who need to meet the legal requirements for working with fluorinated gases, and other ozone depleting substances.

Key Learning Areas Covered In This Course:

- Basic systems, principles and units and how they relate to theory and thermodynamics of vapour compression cycles and refrigerants
- Causes and effects of global warming and ozone depletion
- Identification of air conditioning and heat pump components, functions and leakage risk
- Hazards and safe working practices
- Construction and examination of pipe work
- Recovery of refrigerant and oil and prepare for disposal
- Pressure testing, evacuation and record completion
- Refrigerant charging, leak checking and record keeping
- Fabrication and fitting of mechanical and brazed joints

F-Gas (Category 3) | City & Guilds 2079-13

📍 York and Slough | 2 Day | **Price on Request**

Course Overview:

This City & Guilds course will provide you with the knowledge and practical skills to undertake refrigerant recovery from stationary refrigeration, air conditioning and heat pump equipment to meet Category III theoretical and practical requirements.

Who Is This Course For:

This course is designed for those working within the refrigeration and air-conditioning industry who need to meet the legal requirements for working with fluorinated gases, and other ozone depleting substances.

Key Learning Areas Covered In This Course:

- Cause and effects of ozone depletion
- Cause and effects of global warming and climate change
- Hazards and safe working practices for the recovery, storage and transportation of recovered refrigerants
- Recovery of refrigerant and oil and preparation for disposal

F-Gas (Category 4) | City & Guilds 2079-14

📍 York, Slough and Livingston | 2 Day | £495

FCAT4

Course Overview:

This City & Guilds course will provide you with the knowledge and practical skills to undertake leak checking of stationary refrigeration, air conditioning and heat pump equipment to meet category IV theoretical requirements.

Who Is This Course For:

This is aimed at those working within the refrigeration, air-conditioning and heat pump sector using fluorinated gases and ozone depleting substances.

Key Learning Areas Covered In This Course:

- Basic standard units and thermodynamics principles of vapour compression cycle
- Cause and effects of global warming and climate change
- Identification of air conditioning and heat pump components, functions and leakage risk
- Hazards and safe working practices for leak checking of stationary refrigerant, air conditioning and heat pump systems
- Cause and effect of ozone depletion
- Undertake leak checking and record keeping

Hydrocarbon Qualification | City & Guilds 6187-21

6187

 York, Slough, Livingston and On-site | 1 Day | **£325**

Course Overview:

This City & Guilds course will provide you with the skills and knowledge to safely handle hydrocarbon refrigerants during installation, service, maintenance and disposal. This course covers all Hydrocarbon refrigerants, including R290 and R600a. It is also suitable for engineers working with flammable HFOs and HFCs including R1234yf, R1234ze and R32.

Who Is This Course For:

This is aimed at experienced engineers who work on systems containing hydrocarbon and flammable refrigerants. To enrol on this course you must be experienced in working with refrigeration and air-conditioning systems and must hold the C&G 2079-11, 2079-12 or equivalent qualification.

Key Learning Areas Covered In This Course:

- Dangers of working with hydrocarbons and identifying hazards
- Regulations for the installation, servicing and de-commissioning of hydrocarbon RAC systems
- Hazards and safe working practices for the recovery, storage and transportation of recovered refrigerants
- Recovery of refrigerant and oil and preparation for disposal



F-Gas Compliance

📍 York, Slough, Livingston and On-site | 2 Day | £525

Course Overview:

This City & Guilds accredited course will enable you to understand your obligations within the F-gas regulations 2014. It will also allow you to oversee work carried out by engineers and contractors whilst maintaining the required documentation.

Who Is This Course For:

This course is aimed at those involved with management of Refrigeration and Air Conditioning Systems containing Ozone Depleting Substances or F-gases and the associated statutory and mandatory legislation and documentation.

Key Learning Areas Covered In This Course:

- The Basic Physics of Air Conditioning and Refrigeration
- SI Units Pressure Temperature
- Principles of Air Conditioning and Refrigeration Systems
- Introduction to the refrigeration Cycle
- Components
- Compressor Condenser
- Expansion Devices Evaporators
- Environmental Issues
- Refrigerant types Hazards
- Protocols Legislation
- Records and Documents
- F-Gas register
- Log Book
- Waste Transfer Environment Agency

Introduction to Air Conditioning

📍 York and Slough | 3 Day | £800

Course Overview:

This City & Guilds accredited course will provide an understanding of Air Conditioning Systems and the processes involved. It will also promote the knowledge required to carry out or manage work on the various systems encountered.

Who Is This Course For:

This is aimed at staff who are involved with working on or overseeing work on Air Conditioning Systems; enabling delegates to not only understand the theory and safety related aspects, but also to be able to do the job.

Key Learning Areas Covered In This Course:

- Introduction to basic mechanical and thermodynamic physics
- Introduction to psychrometry and use of psychrometric charts
- Air conditioning system components
- Principles of air conditioning
- Associated regulations
- Types and practical use of measuring instruments
- Balancing of air conditioning distribution systems



Fire Safety



Course Name	Code	Length	Price Exc. VAT
Fire Safety Responsible Person Introduction	FSRPI	1 Day	£280
Fire Safety Responsible Person Introduction - Healthcare Premises	FSRPIHP	1 Day	£280
Fire Door Survey and Inspection	FDSI	1 Day	£280
Fire and Smoke Damper Survey and Inspection	FSDSI	1 Day	£280
Fire Stopping Survey and Inspection	FSSI	1 Day	£280
Fire Safety Technical Awareness	FSTA	3 Day	£855
Escape Lighting	ESL	2 Day	£445
Fire Alarms and Detection Systems - Commercial	BS5839-1	1 Day	£280
Fire Alarms and Detection Systems - Domestic	BS5839-6	1 Day	£280

Training available in York, Slough, Livingston and On-site

Our Facilities

Fire Safety Practical Training



The Importance of Practical Training

Our brand new practical facilities showcase industry standard installations of fire and smoke dampers, fire stopping measures, fire doors, escape lighting and more. It is paramount that we continue to provide the most up-to-date practical demonstrations, ensuring that delegates can immerse themselves in our real-world installations, improving the delegate experience, and ultimately, increasing competency.

1

Fire Safety Corridor

Designed to mimic the variety of corridors present in many commercial settings, NHS, Office and Industrial environments, etc, delegates will find a wide range of fire precautions for surveying, inspecting and testing in a practical setting.

Installations include:

- Fire Alarms and Detection Systems
- Fire and Smoke Dampers
- Fire Stopping
- Fire Doors (including Anti-Barricade Doors)
- Adaptive Lighting
- Emergency Lighting
- Battery Powered Escape Lighting
- Automated Fire Curtain

2

Fire and Smoke Damper and Fire Stopping Demonstration Area

For use as a practical teaching aid in our Survey and Inspection courses, this area houses the following:

- Motorised Dampers
- Mechanical Curtain Dampers with Fusible Link
- Mechanical Butterfly Damper with Fusible Link and External Reset
- Various Fire Stopping examples; Copper Pipes, Plastic Pipes (PP, PVC and PE), Cables and Cable Trays

3

Fire Doors and Fire and Smoke Damper Area

Where delegates may require closer inspection of equipment to gain a greater understanding of the mechanisms and structural make up of certain fire safety precautions, our facility showcases:

- Fire Door cross-sections
- Access Hatch examples
- Ironmongery and Intumescent Strips
- Large Mechanical Curtain Dampers
- Floor Mounted Dampers

"Excellent and much needed programme. Fire doors, fire stopping and fire dampers are a crucial and complex discipline in which there is no grey area between right and wrong. The fire safety industry is historically plagued with a lack of understanding and we welcome this course to develop understanding within both the applicator and end user market."

Saracen Compliance Services LTD

HTM 05-01 Fire Code Matrix

Find a Course That Suits You

Fire Safety Management Structure

The management of Fire Safety within a healthcare premises can be categorised into 3 main 'levels' of responsibility.



The Fire Safety Management Structure

Level & Premises	Typical Policies and Procedures
Level 1: Acute Hospital, Mental Health Hospital and Diagnostic and Treatment Centres	<ul style="list-style-type: none"> Identifying changes to risk (Proactive) Initiating maintenance or repair Organise training in all aspects of fire safety Logging and auditing routine Liaise with the fire and rescue service Contingency planning
Level 2: Minor Injuries Unit, Primary Care Centre, Multiple GP's, Minor Treatment and Dental Provisions	<ul style="list-style-type: none"> Identifying impact of changes to risk (Reactive) Shared responsibility for fire safety Trained in all aspects of fire Delivering required permits, logs and audits Periodic monitoring of the fire safety system, ensuring equipment is fully functional (Reactive) Liaise with the fire and rescue service Contingency planning
Level 3: Small GP Practice	<ul style="list-style-type: none"> Identifying changes to risk periodically Utilises third party fire safety systems Periodic fire safety training No system of communication with the fire and rescue service Minimal contingency planning

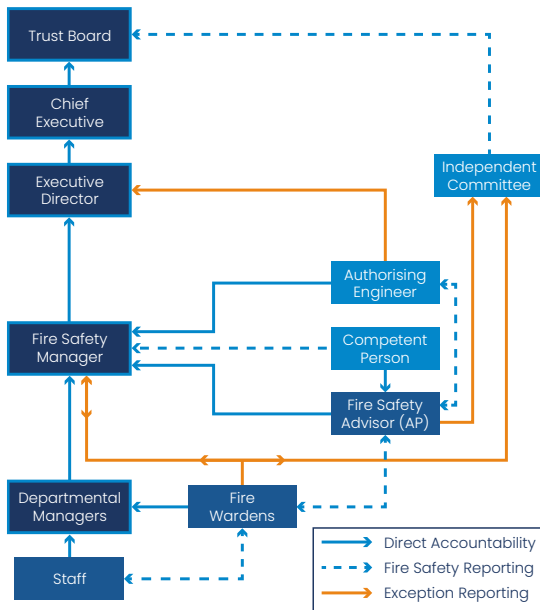

Roles and Responsibilities

Each individual or group should have a role within the fire safety management structure. Depending on the size of the organisation, some roles may be combined or outsourced. Roles include:

1. Trust Board
2. Chief Executive
3. Board Level Director
4. Fire Safety Manager
5. Fire Safety Advisor
6. Authorising Engineer (External)
7. Competent Person (Fire)
8. Local Management
9. Fire Warden
10. Fire Incident Manager
11. Fire Response Team Leader
12. Fire Response Teams
13. Fire Safety Committee

Below are typical examples of specific roles found within the fire safety management structure, and suggested training courses. Please be aware that competent persons carrying out specific duties are advised to attend role-specific survey and inspection training courses.

Fire Safety Roles	
Role	Suggested Course(s)
Executive Director, Fire Safety Manager, Departmental Managers, Fire Safety Advisors	Full Fire Safety Training Programme (All Courses)
Authorising Engineer, Competent Person, Fire Safety Committee	FSTA (page 123) +/- BS5839-1 (page 125) +/- or Any role-specific Survey and Inspection Course: FDSI (page 120) +/- or FSDSI (page 121) +/- or FSSI (page 122)
Staff, Fire Wardens	FSRPIHP (page 119) + FDSI (page 120) +/- or BS5839-1 (page 125)

DCLG Guidance for Your Premises

Find a Course That Suits You

Fire Risk Assessment Guidance

The Department for Communities and Local Government (DCLG) offers guidance for employers, managers, occupiers and owners concerned with various types of premises.

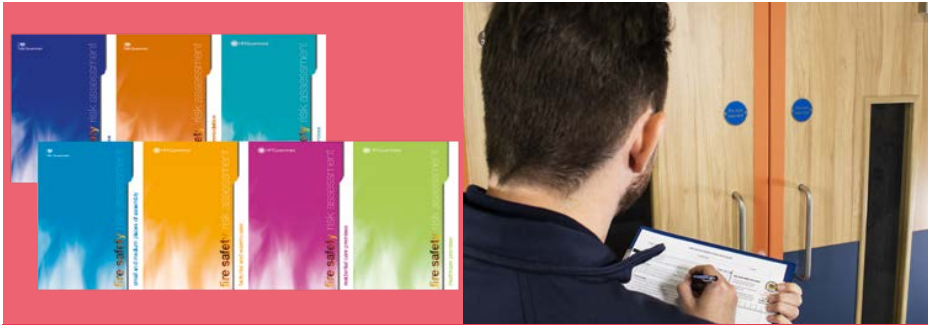

Finding a Course To Suit Your Premises

Your Premises	Our Suggested Fire Safety Course(s)
Offices and Shops	<ul style="list-style-type: none"> • Fire Safety Responsible Person Introduction • Fire Door Survey and Inspection • Fire Alarms and Detection Systems (Commercial)
Sleeping Accommodation	<ul style="list-style-type: none"> • Fire Safety Responsible Person Introduction • Fire Door Survey and Inspection • Fire Alarms and Detection Systems (Commercial) • Fire Stopping Survey and Inspection • Escape Lighting
Educational Premises	<ul style="list-style-type: none"> • Fire Safety Responsible Person Introduction • Fire Door Survey and Inspection • Fire Alarms and Detection Systems (Commercial)
Places of Assembly	<ul style="list-style-type: none"> • Fire Safety Responsible Person Introduction • Fire Door Survey and Inspection • Fire Alarms and Detection Systems (Commercial) • Escape Lighting



Factories and Warehouses	<ul style="list-style-type: none"> • Fire Safety Responsible Person Introduction • Fire Alarms and Detection Systems (Commercial) • Escape Lighting
Residential Care Premises	<ul style="list-style-type: none"> • Fire Safety Responsible Person Introduction • Fire Safety Responsible Person Introduction – Healthcare Premises • Fire Door Survey and Inspection • Fire Stopping Survey and Inspection • Fire Alarms and Detection Systems (Commercial) • Escape Lighting
Healthcare Premises	<ul style="list-style-type: none"> • Fire Safety Responsible Person Introduction • Fire Safety Responsible Person Introduction – Healthcare Premises • Fire and Smoke Damper Survey and Inspection • Fire Door Survey and Inspection • Fire Stopping Survey and Inspection • Fire Alarms and Detection Systems (Commercial) • Escape Lighting



Fire Safety Responsible Person Introduction

📍 York, Slough and Livingston | 1 Day | £280

Course Overview:

This City & Guilds accredited course provides you with the basic understanding of what is required to manage fire safety, as a responsible person, to enable compliance under the Regulatory Reform (Fire Safety) Order 2005 and the Health and Safety at Work Act. Upon completion, you will be issued with a City & Guilds accredited certificate of achievement.

Who Is This Course For:

This course has been designed for estates officers, and any other personnel who have a responsibility in terms of fire safety, who require a detailed level of understanding to ensure you have the competence to manage fire safety within your premises.

Key Learning Areas Covered In This Course:

- Understanding fire safety legislation and the requirements of the RRO 2005
- Identifying fire hazards and their control through routine inspections and assessments
- Identify any fire safety management deficiencies
- Review of fire risk assessments
- Maintenance of fire safety records and documentation
- Management and maintenance of fire emergency plans

Fire Safety Responsible Person Introduction – Healthcare Premises

📍 York, Slough and Livingston | 1 Day | £280

FSRPHHP

Course Overview:

This City & Guilds accredited course provides you with the basic understanding of what is required to manage fire safety in the healthcare environment, to then enable compliance under the Regulatory Reform (Fire Safety) Order 2005, the Health and Safety at Work Act and HTM 05-01 Managing healthcare fire safety. Upon completion, you will be issued with a City & Guilds accredited certificate of achievement.

Who Is This Course For:

This course has been designed for healthcare/estates officers and other personnel with a fire safety responsibility, who require a detailed level of understanding to ensure you have the competence to manage fire safety in the healthcare environment.

Key Learning Areas Covered In This Course:

- Understanding fire safety legislation and the requirements of the RRO 2005 and HTM 05-01
- Understanding the fire safety management structure within the healthcare environment
- Identifying major fire hazards and their control through routine inspections and assessments
- Identify any fire safety management deficiencies
- Review of fire risk assessments
- Maintenance of fire records, documentation and the fire emergency plan
- Management of fire emergency plans



Fire Door Survey and Inspection

FDSI

📍 York and Slough | 1 Day | £280

Course Overview:

This City & Guilds accredited course incorporates the latest legislation, guidance and manufacturers standards to enable the surveying and routine testing of dampers within the healthcare environment. The course includes practical examples of what to expect with the typical fire & smoke damper installation in a variety of areas. Together the theory and practical elements will assist in compliance with the Regulatory Reform (Fire Safety) Order, HTM 05-02, BS9999 and site fire safety maintenance requirements. Upon completion, you will be issued with a City & Guilds accredited certificate of achievement.

Who Is This Course For:

This course has been designed for healthcare/estates engineers and other personnel. The delegate will gain sufficient knowledge and information to conduct duties required by the RRO and within BS9999 and HTM 05-02, including the production of the associated inspection and test report. This will help in achieving compliance with all regulatory requirements and with following best practice in line with guidance documents.

Key Learning Areas Covered In This Course:

- Introduction to the associated legislation, industry guidance & specifications in relation to ventilation system fire safety
- A general understanding of the requirements of BESA guidance documents DW 144/145, TRI9 and DW172
- A general understanding of BS EN 9999 Code of practice for fire safety in the design, management and use of buildings
- The maintenance requirements of NHS HTM 05-02: Guidance in support of functional provisions for healthcare premises
- Installation requirements of fire and smoke dampers
- Identify defects in fire compartmentation associated with incorrect damper installation
- Test fire and smoke dampers to correct requirements within their respective environments

Fire and Smoke Damper Survey and Inspection

📍 York and Slough | 1 Day | £280

Course Overview:

This City & Guilds accredited course incorporates the latest legislation, guidance and manufacturers standards to enable the surveying and routine testing of dampers within the healthcare environment. The course includes practical examples of what to expect with the typical fire & smoke damper installation in a variety of areas. Together the theory and practical elements will assist in compliance with the Regulatory Reform (Fire Safety) Order, HTM 05-02, BS9999 and site fire safety maintenance requirements. Upon completion, you will be issued with a City & Guilds accredited certificate of achievement.

Who Is This Course For:

This course has been designed for healthcare/estates engineers and other personnel. The delegate will gain sufficient knowledge and information to conduct duties required by the RRO and within BS9999 and HTM 05-02, including the production of the associated inspection and test report. This will help in achieving compliance with all regulatory requirements and with following best practice in line with guidance documents.

Key Learning Areas Covered In This Course:

- Introduction to the associated legislation, industry guidance & specifications in relation to ventilation system fire safety
- A general understanding of the requirements of BESA guidance documents DW 144/145, TR19 and DW172
- A general understanding of BS EN 9999 Code of practice for fire safety in the design, management and use of buildings
- The maintenance requirements of NHS HTM 05-02: Guidance in support of functional provisions for healthcare premises
- Installation requirements of fire and smoke dampers
- Identify defects in fire compartmentation associated with incorrect damper installation
- Test fire and smoke dampers to correct requirements within their respective environments

Fire Stopping Survey and Inspection

📍 York and Slough | 1 Day | £280

Course Overview:

This City & Guilds accredited course intends to 'up-skill' those working with the fabric of the building. This will give knowledge and understanding in relation to the checking of fire stopping and compartmentation arrangements with respect of fire safety. This is in accordance with the requirements of the Regulatory Reform (Fire Safety) Order, HTM 05-02/3 and the respective fire safety protocol. Upon completion, you will be issued with a City & Guilds accredited certificate of achievement.

Who Is This Course For:

This course has been designed for healthcare/estates engineers and other personnel. The delegate will gain sufficient knowledge to ensure compartmentation and structural fire safety is not compromised during and after work has been carried out, therefore maintaining compliance with all regulatory and guidance requirements.

Key Learning Areas Covered In This Course:

- Legal requirements for fire stopping and compartmentation
- Identify how fire compartmentation is established within buildings
- Installation requirements of penetration sealing systems
- Typical types of penetration and their respective fire stopping arrangements
- Fire stopping performance and typical defects
- Typical installation and maintenance requirements of fire stopping systems.
- Cavity barriers, fire curtains and smoke barriers

Fire Safety Technical Awareness

📍 York and Slough | 3 Day | £855

Course Overview:

This City & Guilds accredited course incorporates the latest legislation, guidance and manufacturers standards, along with hands on practical experience to enhance the technical understanding of nominated fire safety personnel within the healthcare/ estates environment. The course focuses on specific hardware associated with passive fire safety including fire dampers and fire doors. Active fire safety measures such as fire alarms and emergency lighting will also be covered within this course. Upon completion, you will be issued with a City & Guilds accredited certificate of achievement.

Who Is This Course For:

This course has been designed for healthcare/estates fire safety personnel, where the delegate will gain sufficient knowledge to understand the practical elements that may be detailed within a trust fire risk assessment, and experience examples of good and bad within the respective subject matter.

Key Learning Areas Covered In This Course:

- Introduction to the associated legislation, industry guidance & specifications in relation to fire safety
- A general understanding of the requirements for; fire dampers and their testing requirements, fire doors and basic fault identification, fire stopping and compartmentation, along with basic survey, fire alarm systems and their testing requirements, and emergency lighting, including its role in horizontal evacuation
- Practical examples of the different types of equipment/systems used in passive fire safety, along with undertaking functional tests/surveys to increase overall understanding
- The maintenance requirements of NHS HTM 05-02: Guidance in support of functional provisions for healthcare premises
- The importance of a robust management system and record keeping



Escape Lighting

📍 York, Slough and On-site | 2 Day | £445

Course Overview:

This City & Guilds accredited course has been developed to assist delegates in gaining the knowledge required to carry-out design of emergency lighting systems to comply with BS5266. The training also covers the certification requirements, and the maintenance of emergency lighting systems in accordance with BS5266.

Who Is This Course For:

This Escape Lighting training course is aimed at electrical staff who have responsibility for carrying out planned maintenance of emergency lighting installations at their place of work.

Key Learning Areas Covered In This Course:

- Introduction to types of emergency lighting and requirements of BS5266
- Design of emergency lighting systems
- Risk assessment
- Commissioning requirements and measurement of performance
- Battery types and charging systems
- Maintenance and testing of installations in accordance with British standards
- Installation and certification
- Practical design exercise and measurement of lighting levels

Fire Alarms and Detection Systems - Commercial

 York, Slough and On-site | 1 Day | **£280**

BS5839-1

Course Overview:

The course is written to provide a basic knowledge and understanding of the major parts of BS5839 Part 1, covering the requirements for fire alarm and detection systems in commercial installations.

Who Is This Course For:

The course is designed for any electrician who has a responsibility for installation or maintenance of Commercial Fire Alarm and Detection Systems and provides an in-depth introduction. The course concludes with a written examination.

Key Learning Areas Covered In This Course:

- The legal requirements for fire alarm and detection systems
- The necessity for a Fire Risk Assessment.
- Basic design requirements for a fire alarm and detection System, detailing grades and categories
- Components and equipment options, necessary for a fire alarm and detection system
- Installation requirements for components and equipment
- Cross-over between BS5839 Part 1 and Part 6
- Necessary testing, maintenance and reporting procedures



Fire Alarms and Detection Systems – Domestic

 York, Slough and On-site | 1 Day | **£280**

Course Overview:

The course is written to provide a basic knowledge and understanding of the major parts of BS5839 Part 6, covering the requirements for fire alarm and detection systems in domestic installations.

Who Is This Course For:

The course is designed for any electrician who has a responsibility for installation or maintenance of Domestic Fire Alarm and Detection Systems, including HMOs, and provides an in-depth introduction. The course concludes with a written examination.

Key Learning Areas Covered In This Course:

- The legal requirements for fire alarm and detection systems
- The necessity for a Fire Risk Assessment
- Basic design requirements for a fire alarm and detection system for domestic dwellings
- Components and equipment options, necessary for a fire alarm and detection system, including interlinking
- Installation requirements for components and equipment
- Full explanation of the requirements for HMOs, detailing variations depending on type of facility
- Necessary testing, maintenance and recording procedures



York Campus

We also offer bespoke training solutions to suit your needs. These solutions can have their own benefits to you and your team:

View on Google Maps or What3Words:

PPL House, 6 Opus Avenue, York YO26 6BL
[///gear.ripe.notes](https://www.gear.ripe.net)

Unit 4, Tudor Court, York YO26 6RS
[///slim.even.stuck](https://www.slim.even.stuck.com)



Our Facilities

York has been our home at PPL Training since the company's inception. Growing from a 400ft² warehouse unit on James Street in York to what is now an enterprise spanning 3 locations and with over 50,000ft² of training facilities.



In 2013 the company moved to York Business Park as we solidified our focus on Mechanical and Electrical training, curating training facilities to suit our ever-expanding curriculum of courses.

In 2019 We acquired Tudor Court, just over the road from the bulk of our centres on Opus Avenue, and in 2021 we received the keys to Unit 8. Find out what each individual centre plays host to below:

Classrooms

Practical Facilities

Unit 5

- Dirac
- Edison
- Davy
- Mechanical and Pressure Systems
- Mechanical and Electrical Conversion
- F-Gas Handling
- Medical Gas Pipeline Systems
- Ventilation



Unit 6

- Dyson
- Stephenson
- Faraday
- High Voltage Ring 1
- Low Voltage
- Airfield Lighting
- Confined Spaces (outside at rear)

Unit 8

- Hertz
- Watt
- Connelly
- Hawksley Exam Suite
- Fire Safety
- High Voltage Ring 2
- Hazardous Areas
- Petroleum
- Low Voltage



Unit 4 - Tudor Court

- Joule
- Franklin
- Fleming
- Electrical Installations
- Legionella (Water Hygiene)

📍 Slough Campus

We also offer bespoke training solutions to suit your needs. These solutions can have their own benefits to you and your team:



Malton Ave

468 Malton Avenue, Slough SL1 4QU

///audit.supply.master



Bedford Ave

108 Bedford Avenue, Slough SL1 4RA

///metal.stress.lasts



Buckingham

103 Buckingham Ave, Slough SL1 4PF

///foods.sunk.focal

Our Facilities

In 2015, as part of a planned expansion, we opened our flagship centre in the south, 468 Malton Avenue. Affectionately known as PPL House, this centre formed the base for what we now have, a campus of 3 buildings, spanning the Slough Trading Estate.

Now with 108 Bedford Avenue and 103 Buckingham Avenue now online, we have been able to replicate the practical training facilities that we have in York, covering all disciplines within our portfolio of training courses:

Classrooms

Practical Facilities

468 Malton Avenue

- Swan
- Cayley
- Bell
- Maxwell
- Brunel
- Newton
- High Voltage
- Low Voltage
- Ventilation
- Medical Gas Pipeline Systems
- Airfield Lighting
- Hazardous Areas
- Confined Spaces
- Petroleum





108 Bedford Avenue

- Babbage
- Snow
- Harrison
- Electrical Installations
- Legionella (Water Hygiene)

103 Buckingham Avenue

- Carrier
- Law
- Smith
- Shilling
- Fire Safety
- Mechanical and Pressure Systems
- F-Gas Handling
- Unvented Hot Water Systems
- Mechanical and Electrical Conversion

Livingston Centre

We also offer bespoke training solutions to suit your needs. These solutions can have their own benefits to you and your team:

View on Google Maps or What3Words:

5 Deer Park Avenue, Fairways Business Park,
Livingston EH54 8AF
[///train.pets.walks](https://train.pets.walks)



Our Facilities

5 Deer Park Avenue, our Livingston Centre, is complete with 4 spacious classrooms, 1 efficiently condensed practical area, and is within walking distance of the local Premier Inn accommodation.

This centre offers a convenient solution to our clients in Scotland who may wish to lessen their travel time and remain closer to home. Situated just off of the M8, (JCT 3) this centre is also located close to the Deer Park Golf Course, also on the Fairways Business Park.

The centre is staffed by our Livingston team, comprising of tutors and dedicated client services team member.

Classrooms

5 Deer Park Avenue

- Bateman
- Blyth
- Bruce
- Weir

Practical Facilities

- F-Gas Handling
- Low Voltage
- Mechanical and Pressure Systems
- Mechanical and Electrical Conversion



See More Online

View the centre floor plan, see the courses available in Livingston and watch a video tour of the centre by visiting our website:

 ppltraining.co.uk/training-facilities/livingston-centre



Meet Our Knowledgeable and Experienced Team of Tutors

Staff Profiles



View Online

Bespoke Training Solutions

We also offer bespoke training solutions to suit your needs. These solutions can have their own benefits to you and your team:



In-Centre Training

- Multiple centres across the UK
- Wide range of practical facilities
- Safe, quiet and clean environment



Remote Training

- A variety of live tutor-led courses and self-paced learning
- Cost effective
- Reduced downtime

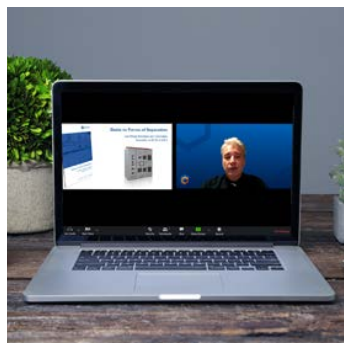

On-site, at Your Premises

- Reduced downtime
- Dates to suit your team
- Cost effective team training



Increase your Competency

Our in-centre training offers hands-on practical learning, demonstrations and assessments designed to help ensure the technical competencies of your staff.

We've Got a Guide for That!

To explain that the majority of our in-centre training is underpinned by practical training designed to increase your competency and technical knowledge, is pretty easy to do...

However, to show you what our practical training facilities look like, in a way that you can appreciate the scale of it, is not as easy! Check out the web page below for more details

 ppltraining.co.uk/our-latest-training-brochures



Enter The Digital Classroom

We offer a selection of live, tutor-led remote training courses, and will soon offer self-paced e-learning options for those who need to train in their own time...



Legionella Management for Water Systems Remote



Legionella Awareness Remote



Water Hygiene Training For Hospital Maintenance Staff HTM 04-01 Remote



Legionella Management for Water Systems HTM 04-01 Remote



Closed Water Systems Awareness Remote



Substation Entry Awareness Remote

For pricing and availability, visit:  ppltraining.co.uk/training-course/remote-training

At Your Premises, For Your Team

If you have the facilities, we have the expertise. Why not have us come to you? A number of our courses can be delivered on-site on a bespoke basis:

- ✓ 18th Edition Wiring Regulations | City & Guilds 2382-18
- ✓ Hydrocarbon Qualification | City & Guilds 6187-21
- ✓ Aeronautical Ground Lighting Technician
- ✓ Authorised Person Aeronautical Ground Lighting
- ✓ Authorised Person Confined Spaces (Commercial)
- ✓ Authorised Person Confined Spaces Refresher
- ✓ Authorised Person MOD Hazardous Areas
- ✓ Authorised Person High Voltage - Operation and Safety
- ✓ Authorised Person High Voltage - HTM 06-03
- ✓ AP/SAP High Voltage - MOD Sectors
- ✓ Authorised Person Electrical Low Voltage
- ✓ Authorised Person Electrical Low Voltage HTM 06-02
- ✓ Authorised Person Mechanical and Pressure Systems
- ✓ Authorised Person Petroleum
- ✓ Authorised Person Petroleum Refresher
- ✓ Authorised Person Ventilation HTM 03-01
- ✓ Authorised Person Ventilation Refresher HTM 03-01
- ✓ Authorised Person Working At Height (MOD)
- ✓ Authorised Person Working At Height (Commercial)
- ✓ Authorising Engineer
- ✓ Fire Alarms and Detection Systems - Commercial
- ✓ Fire Alarms and Detection Systems - Domestic
- ✓ Competent Person Confined Spaces
- ✓ Competent Person Confined Spaces Refresher
- ✓ Competent Person Electrical Low Voltage HTM 06-02
- ✓ Competent Person Ventilation HTM 03-01
- ✓ Authorised Person Confined Spaces (MOD)
- ✓ Escape Lighting
- ✓ F-Gas Compliance
- ✓ Facilities Management Contract Managers Technical Awareness



High Voltage Awareness



Mechanical to Electrical Conversion



Skilled Person Mechanical and Pressure Systems



Water Regulations



Legionella Management for Water Systems



Legionella Awareness



Legionella and Water Hygiene Control Within Hot and Cold Water Systems



Risk Assessment for Legionella and Water Hygiene Control in Water Systems



Disinfection of Hot and Cold Water Systems



Control of Legionella Within Evaporative Cooling Systems



Legionella Control Refresher and Update



Legionella Control and Management of Hot and Cold Water Services and Evaporative Cooling Systems



Introduction to The Risk of Pseudomonas aeruginosa and Other Waterborne Pathogens



Swimming and Hydrotherapy Pool Operation and Management



Servicing and Testing Requirements of Thermostatic Mixing Valves (TMV)



Water Hygiene Training For Hospital Maintenance Staff



Legionella Management for Water Systems HTM 04-01



Legionella Awareness Hospital HTM 04-01



Legionella and Water Hygiene Control Within Hot and Cold Water Systems HTM 04-01



Enquire Now

On-site course pricing may vary to those listed elsewhere in this brochure.

Appropriate facilities are required in order for PPL Training to deliver on-site training at your premises. Ask our Account Managers if your facilities qualify.

How Can We Help You?

Take a look at some of the organisations that have trained with us in 2022 and continue to do so as they look to increase and maintain the competency of their teams...

See More of



Our Clients



Training for Facilities Management Teams

Our training course programme is a one-stop-shop for Facilities Management organisations who are looking to prove their competency or demonstrate their technical skills with our range of City & Guilds Accredited courses.



"PPL Training offer a premium service with regards to technical training."

"They can offer a one stop solution, the training courses, sorting out accommodation and any other special requirements, just talk to their administration staff.

The instructors/lectures make the sessions very interesting & enjoyable by calling upon their own experiences and many years' time served in industry and services.

The finish product being a recognised qualification."

ISS

City & Guilds Accredited
Authorising Engineer

HTM Compliance for Healthcare Estates

We deliver courses designed to help ensure Healthcare providers meet the requirements of NHS HTM guidance documentation. In 2022, 500+ delegates sat these courses. This happened through direct partnerships with NHS trusts or by serving as a training provider for Facilities Management organisations, responsible for healthcare premises.



As IHEEM Knowledge Partners, our team of knowledgeable and experienced tutors will often take part in peer review of upcoming editions of HTM Guidance, ensuring our training is up-to-date and accurate, in-line with the latest standards.

Recently, our portfolio of courses expanded to include training for SHTM guidance with the opening of our Livingston Centre.



"Great training provider, great tutor, great course content, great venue."

"The package from start to finish was excellent, from first enquiry to finding out I had passed the course. The most important elements on any course are the content and the tutor. The content met my needs very well but more importantly, the content was expertly delivered, by an excellent trainer.

Ian adapted the delivery of the content to suit our needs and I actually took this for granted until after the exams on the final day while I was reviewing the course. Ian doing this gave us a much greater chance of not only passing the course, but helping us to remember and implement what we had learned when back in our work places.

Ian has a refreshing personality too which really helps when learning quite serious subject matter!

The accommodation was close to the training venue which was helpful. The training venue was a good teaching space and cooled by AC. The workshop with all of switchgear from different manufacturers was a good place to familiarise yourself with switchgear you may not have on site (and for preparing for the exams). The lunches were fresh and more than enough for your average delegate."

Whipps Cross University Hospital NHS Trust

City & Guilds Accredited
Authorised Person High Voltage HTM 06-03

Partnering with University Engineers

As AUE Academy Learning and Development partners, and supporters of the AUDE, we have provided a host of Authorised and Skilled Person, Mechanical and Electrical Conversion and Water Hygiene courses to over 20 Universities in the UK.



"Carl is amazing"

"Carl was an amazing teacher, he explained everything and answered any questions we had... Can't wait for my next load of training with you guys"

University of Surrey

City & Guilds Accredited
Authorised Person Mechanical and Pressure Systems

Servicing Defence

Last year at PPL Training, we welcomed well over 200+ delegates to our centres, who represented the Ministry of Defence or contractors who oversee Estates and Facilities Management in Military environments.



"Great training provider, great tutor, great course content, great venue."

"From initial contact with Amanda Scott I found PPL friendly and helpful.

Paul Davey was a very good trainer and the PPL premises at York are very good training facility.

I have applied to undertake the APHV1 course and hopefully the follow-on APHV3 with PPL.

Well catered for, the Vegan packed lunch was the best I have received on any training course I have attended from any provider..."

Amey Defence Services

City & Guilds Accredited
Authorised Person Electrical Low Voltage

Training for Airfields and Aviation

We offer a suite of training courses designed for all aspects of Airfield Lighting maintenance and management. We welcomed close to 20 of the UK's largest Airports to our centres in 2022, with more receiving on-site training, at their premises.



"Brilliant Course"

"Steve Martin was excellent and has a vast amount of knowledge. Best course I've ever been on."

States of Guernsey

Aeronautical Ground
Lighting Technician

Everyone In-Between

Our existing client base is rather varied, with everyone from large commercial enterprises and small to medium businesses. From Water Treatment firms, to Local Government employees, all have attended our centres.



"Excellent facilities, course content and facilitator knowledge."

"The course included the right level of detail for my role requirements. The tutor had extensive knowledge and kept the group included with taught content.

The training suite was 5 minutes walk from accommodation and refreshments provided were excellent.

I would highly recommend!"

Safran Group

City & Guilds Accredited Legionella Control and Management of Hot and Cold Water Services and Evaporative Cooling Systems

Get Social

Let us know how we did, or follow us to keep an eye out for news, reviews, course information and events that might be of interest to you...

Join The Conversation

Our posts in 2023 have reached over **10,000 LinkedIn users**, that's up from 3,900 users in the same period of 2022.

10K

connections

📈 164% from 3.9K

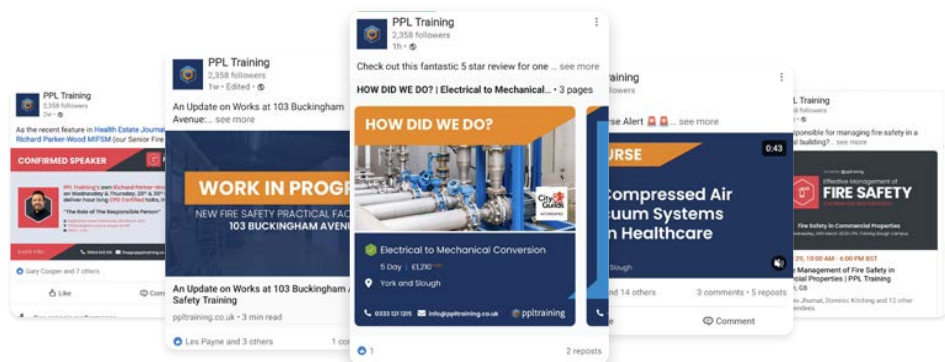

NEWS | REVIEWS | VIDEOS | EVENTS | PEOPLE | TRAINING

Follow Us



On LinkedIn

Help us reach our target of 3000 followers by the end of 2023!



We're Growing

Our LinkedIn following has grown from 1.7K followers at the end of 2021 to **over 2.3k followers** as we entered 2023.

LinkedIn Follower Trend - PPL Training

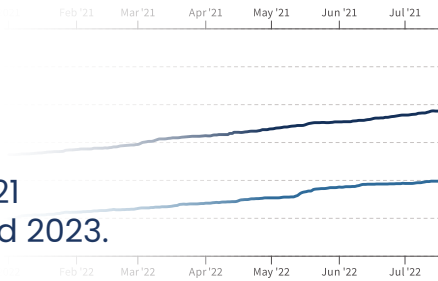

How Did We Do?

We've been given a Platinum Trusted Service Award for yet another year, based on us receiving 300+ verified reviews.

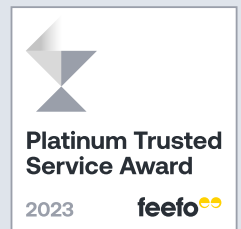

Did You Know? Our Authorised Person Low Voltage course was our highest rated course of 2022!



pplengineering services

We can offer you a personalised solution to your challenges. From regulations, auditing, support and information – we have you covered.



Authorising Engineer Consultancy



Electrical Discrimination Studies



Authorised Person Services



Compliance Audits



Asset/Condition Survey











CDM Support



Safe Systems of Work

Safe Systems of Work for Key Engineering Disciplines

	High Voltage		Mechanical and Pressure Systems
	Low Voltage		Confined Spaces
	Medical Gas		Working at Height
	Ventilation		Lifts

Providing Support and Advice for HTM and SSoW Compliance in your Organisation or Trust, Utilising Our Team of Authorising Engineers.

ENGINEERING SOLUTIONS
UNDER ONE ROOF

Scan the QR code

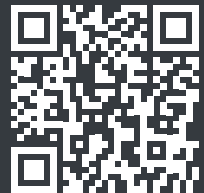

visit our website

Training Course Index

For ease of reference, we have provided a full list of all of our training course, including remote and on-site courses, in alphabetical order based on their course code.

Course Title	Code	Length	Price Exc VAT
18th Edition Wiring Regulations City & Guilds 2382-22	2382-22	3 Day	£500
18th Edition Wiring Regulations Amendment 2 - Update	2382-UP	1 Day	£320
Inspection, Testing and Certification of Electrical Installations City & Guilds 2391-52	2391-52	7 Day	£1,155
Fundamental Inspection and Electrical Testing City & Guilds 2392-10	2392	4 Day	£750
Design and Verification of Electrical Installations City & Guilds 2396	2396	5 Day	£875
Electric Vehicle Charging Equipment Installation City & Guilds 2919-01	2919	2 Day	£455
Hydrocarbon Qualification City & Guilds 6187-21	6187	1 Day	£325
Authorised Person Aeronautical Ground Lighting (MOD)	AGLMOD	Price on Request	
Aeronautical Ground Lighting Maintenance (Systems Management)	AGLSM	3 Day	£895
Aeronautical Ground Lighting Technician	AGLT	5 Day	£1,385
Authorised Person Aeronautical Ground Lighting	APAGL	3 Day	£895
Authorised Person Confined Spaces (Commercial)	APCS	4 Day	£1,195
Authorised Person Confined Spaces Refresher	APCSR	3 Day	£895
Authorised Person MOD Hazardous Areas	APHAZ	3 Day	£895
Authorised Person High Voltage - Operation and Safety	APHV1	5 Day	£1,385
Authorised Person High Voltage - HTM 06-03	APHV2	5 Day	£1,385
AP/SAP High Voltage - MOD Sectors	APHV3	5 Day	£1,385
SAP High Voltage - Commercial and Industrial Sectors	APHV4	5 Day	£1,385
Authorised Person Electrical Low Voltage	APLV	4 Day	£1,195
Authorised Person Electrical Low Voltage HTM 06-02	APLVH	5 Day	£1,385
Authorised Person Electrical Low Voltage HTM 06-02 Refresher	APLVR	3 Day	£895
Authorised Person Medical Gas Pipeline Systems HTM 02-01	APMGPS	5 Day	£995
Authorised Person Medical Gas Pipeline Systems Refresher HTM 02-01	APMGPSR	3 Day	£795



Authorised Person Mechanical and Pressure Systems	APMPS	4 Day	£1,195
Authorised Person Petroleum	APP	4 Day	£1,195
Authorised Person Petroleum Refresher	APPR	3 Day	£895
Authorised Person Ventilation HTM 03-01	APV	5 Day	£1,385
Authorised Person Ventilation Refresher HTM 03-01	APVR	3 Day	£895
Authorised Person Working At Height (MOD)	APWH	3 Day	£895
Authorised Person Working At Height (Commercial)	APWHC	3 Day	£895
Authorising Engineer	AUENG	2 Day	£625
Fire Alarms and Detection Systems - Commercial	BS5839-1	1 Day	£280
Fire Alarms and Detection Systems - Domestic	BS5839-6	1 Day	£280
Competent Person Confined Spaces	CPCS	2 Day	£525
Competent Person Confined Spaces Refresher	CPCSR	1 Day	£285
Skilled/Competent Person Electrical Low Voltage	CPLV	2 Day	£525
Competent Person Electrical Low Voltage HTM 06-02	CPLVH	2 Day	£525
Competent Person Medical Gas Pipeline Systems HTM 02-01	CPMGPS	5 Day	£995
Competent Person Medical Gas Pipeline Systems Refresher HTM 02-01	CPMGPSR	3 Day	£795
Competent Person Ventilation HTM 03-01	CPV	3 Day	£895
Authorised Person Confined Spaces (MOD)	CSMOD	5 Day	£1,385
Dental Compressed Air and Vacuum Systems for use in Healthcare	DAVS	2 Day	£525
Electrical to Mechanical Conversion	EMC	5 Day	£1,210
Escape Lighting	ESL	2 Day	£445
Legionella Management for Water Systems Remote	EWH001	1 Day	£265
Legionella Awareness Remote	EWH002	1 Day	£265
Closed Water Systems Awareness Remote	EWH013	1 Day	£265
Water Hygiene Training For Hospital Maintenance Staff HTM 04-01 Remote	EWH020	1 Day	£265



Legionella Management for Water Systems HTM 04-01 Remote	EWHH01	1 Day	£265
Legionella Management for Water Systems (Scottish) SHTM 04-01 Remote	EWHS01	1 Day	£255
F-Gas (Category 1) City & Guilds 2079-11	FCAT1	5 Day	£975
F-Gas (Category 2) City & Guilds 2079-12	FCAT2	Price on Request	
F-Gas (Category 3) City & Guilds 2079-13	FCAT3	Price on Request	
F-Gas (Category 4) City & Guilds 2079-14	FCAT4	2 Day	£495
Fire Door Survey and Inspection	FDSI	1 Day	£280
F-Gas Compliance	FGCOM	2 Day	£525
Facilities Management Contract Managers Technical Awareness	FMTA	2 Day	£525
Fire and Smoke Damper Survey and Inspection	FSDSI	1 Day	£280
Fire Safety Responsible Person Introduction	FSRPI	1 Day	£280
Fire Safety Responsible Person Introduction - Healthcare Premises	FSRPIHP	1 Day	£280
Fire Stopping Survey and Inspection	FSSI	1 Day	£280
Fire Safety Technical Awareness	FSTA	3 Day	£855
Helicopter Landing Areas for Hospitals	HLAH	2 Day	£525
Heliports Visual Aids Principles	HPVA	2 Day	£525
High Voltage Awareness	HVASM	2 Day	£525
High Voltage Maintenance	HVM	5 Day	£1,385
High Voltage Technical	HVTA	3 Day	£895
Introduction to Air Conditioning	IAC	3 Day	£800
Mechanical to Electrical Conversion	MEC	5 Day	£1,210
Skilled Person Mechanical and Pressure Systems	SPMPS	2 Day	£525
Standby Systems	STBS	3 Day	£895
Substation Entry Awareness	SUBE	1 Day	£295
Unvented Hot Water Storage	UHWS	1 Day	£335
Validation and Verification of Healthcare Ventilation Systems HTM 03-01	VVH	3 Day	£895



Water Regulations	WARE	1 Day	£335
Legionella Management for Water Systems	WH001	1 Day	£295
Legionella Awareness	WH002	1 Day	£295
Legionella and Water Hygiene Control Within Hot and Cold Water Systems	WH003	3 Day	£895
Risk Assessment for Legionella and Water Hygiene Control in Water Systems	WH004	3 Day	£895
Disinfection of Hot and Cold Water Systems	WH005	1 Day	£295
Control of Legionella Within Evaporative Cooling Systems	WH006	3 Day	£895
Legionella Control Refresher and Update	WH007	1 Day	£295
Legionella Awareness Within Evaporative Cooling Systems	WH008	1 Day	£295
Written Scheme of Control - Implementation of the Monitoring Requirements for Hot and Cold Water Systems	WH009	1 Day	£295
Legionella Control and Management of Hot and Cold Water Services and Evaporative Cooling Systems	WH010	5 Day	£1,160
Introduction to The Risk of Pseudomonas aeruginosa and Other Waterborne Pathogens	WH011	1 Day	£315
Swimming and Hydrotherapy Pool Operation and Management	WH012	1 Day	£315
Closed Water Systems Awareness Course	WH013	1 Day	£295
Servicing and Testing Requirements of Thermostatic Mixing Valves (TMV)	WH018	1 Day	£295
Water Hygiene Training For Hospital Maintenance Staff	WH020	1 Day	£295
Legionella Management for Water Systems HTM 04-01	WHH01	1 Day	£295
Legionella Awareness Hospital HTM 04-01	WHH02	1 Day	£295
Legionella and Water Hygiene Control Within Hot and Cold Water Systems HTM 04-01	WHH03	3 Day	£895
Legionella Management for Water Systems SHTM 04-01	WHS01	1 Day	£295
Legionella Awareness Hospital SHTM 04-01	WHS02	1 Day	£295
Legionella and Water Hygiene Control Within Hot and Cold Water Systems SHTM 04-01	WHS03	3 Day	£895





Mechanical and Electrical Training Courses

Nationwide, International, and Online

Training Centres

York

PPL House, 6 Opus Avenue, York Business Park,
Nether Poppleton, York, YO26 6BL

Malton Avenue (Slough)

468 Malton Avenue, Slough Trading Estate,
Slough, SL1 4QU

Buckingham Avenue (Slough)

103 Buckingham Avenue, Slough, SL1 4PF

Tudor Court (York)

Unit 4 Tudor Court, Nether Poppleton, York,
YO26 6RS

Bedford Avenue (Slough)

180 Bedford Avenue, Slough Trading Estate,
Slough, SL1 4RA

Deer Park Avenue (Livingston)

5 Deer Park Avenue, Livingston, EH54 8AF

Opening Hours

Monday – Thursday: 08:45 – 17:30 | **Friday:** 08:45 – 17:00

City & Guilds Approved

Courses in line with latest legislation and approved to the high standards of City & Guilds.



Delivering Excellence as Standard

We have received Platinum Trusted Service Status based on 300+ verified independent reviews (2022/2023). View our feedback online.



Contact Us

 0333 121 0382

 info@ppltraining.co.uk

 ppltraining.co.uk



Scan the QR code to save
our contact information